

**PROVISION** **ISR**®

*Now you can see!*



Catalog January 2022

**FOLLOW THE RED LINE**

---

# Catalog

## Index

• Provision-ISR	pag. 2
• NDAA	pag. 4
• OSSIA O.S.	pag. 5
• OSSIA VMS	pag. 6
• Provision Cam2	pag. 7
• SHOB	pag. 8
• LPR	pag. 9
• DDA™ Video Analytics	pag. 10
• Face recognition	pag. 12
• IP S-Sight 2MP	pag. 15
• IP S-Sight 4MP	pag. 16
• IP S-Sight 8MP	pag. 16
• IP Eye-Sight 2MP	pag. 17
• IP Eye-Sight 4MP	pag. 18
• IP Eye-Sight 8MP	pag. 18
• IP Smart-Sight LPR	pag. 19
• IP Smart-Sight Face recognition	pag. 20
• IP Rainbow	pag. 21
• IP Intelligent auto tracking PTZ	pag. 22
• IP Special	pag. 23
• IP Wireless	pag. 23
• NVR 4 CH	pag. 25
• NVR 8 CH	pag. 25
• NVR 16 CH	pag. 25
• NVR 32 CH	pag. 26
• NVR 64 CH	pag. 26
• NVR 128 CH	pag. 26
• POE Accessories	pag. 27
• POE Switch 10/100 MBPS	pag. 28
• POE Switch giga 10/100/1000 MBPS	pag. 28
• HD PRO 2MP	pag. 31
• HD PRO 5MP	pag. 32
• HD PRO 8MP	pag. 32
• HD ULTRA 2MP	pag. 33
• HD Special	pag. 34
• HD PTZ	pag. 34
• DVR 4 CH	pag. 36
• DVR 8 CH	pag. 36
• DVR 16 CH	pag. 37
• DVR 32 CH	pag. 37
• HDMI Accessories	pag. 39
• Balun	pag. 41
• Connectors	pag. 41
• Power supply	pag. 42
• Test monitors	pag. 43
• Keyboards	pag. 43
• Lenses	pag. 44
• Brackets and junction boxes	pag. 45
• OSSIA VMS Dedicated Hardware	pag. 49



## Provision-ISR: Israeli know-how and reliability

---

Israel's primacy in the security market is a globally recognized factor. Since it was formed, the geopolitical tensions that have affected the country have pushed the industry to invest in emergency management, cybersecurity, intelligence, and critical infrastructure protection. All this allowed security manufacturers to gain unparalleled expertise and a worldwide reputation for developing leading-edge security solutions.



### Brand philosophy

Provision-ISR's philosophy focuses on both the importance of human capital and the respect of any business relationship. When it comes to business partners, our professional ethics guide us to protect all the members in the supply chain: from the big distributor to the small installer, while respecting the unique contribution of each one. The company is growing fast, but we are proud to keep our core values of a long partnership built on friendship and co-working.



### Designing process

Founded in 2007, the Israeli company PROVISION-ISR has been responding to the diversified demands of the market, becoming one of the fastest-growing CCTV Brands in the world. Our CCTV devices and software are designed by a highly skilled team of engineers at the R&D department located in Kfar Saba who are striving to develop "intelligent" and advanced solutions while keeping the user interface intuitive and straightforward.



### Attention to vertical markets

Nowadays, a wider variety of vertical markets show an increasing need for video surveillance, and security manufacturers must provide high-performance technologies at a very competitive price. Provision-ISR can accomplish this requirement thanks to a comprehensive product suite including high-definition analog cameras, affordably priced IP with advanced analytics functions, and cutting-edge software solutions.



### Production facilities

While the designing process takes place in Israel, the production facilities are based in Shenzhen (China). This setup allows us to be extremely competitive in the market. Provision-ISR engineers select the best components available on the market and the quality control that follows the production processes allows us to reach the expected top-quality standards.



### Logistics and global distribution

Three Logistics warehouses, strategically located in China, the Netherlands and USA allow Provision-ISR to reach any market in the world guaranteeing a fast and efficient global distribution. Today we serve more than 40 countries through a wide network of official exclusive distributors, who are working as partners to promote and distribute the brand in their regions.



### Knowledge sharing

In today's CCTV market, where products and technologies change every few months, knowledge is the keyword. Our technical specialists release how-to tutorials every time a new solution has launched to the market. Technical webinars are scheduled periodically to update Provision-ISR partners about product upgrades or new features. Last but not least, Provision-ISR roadshows, seminars, training sessions, and workshops take place all over the world in support of distributors, sub-distributors, and installers.



### Product range

Provision-ISR range of products includes high-quality IP and HD cameras, sophisticated recording machines and a complete range of reliable accessories specifically designed for the CCTV market. In addition, Provision-ISR engineers gained unparalleled expertise in developing leading-edge software solutions while keeping their interface simple and intuitive.



### Provision-ISR international projects

Hospitals, shopping centers, industrial complexes, hotels, sports facilities, residential areas, museums, historical buildings: Provision-ISR CCTV solutions are developed to fulfill any security requirement. Through the years, the Brand has gained the trust of the security market, and today the world can count thousands of projects branded by Provision-ISR.





# NDAA Compliance

## NDAA Compliance

The John S. McCain National Defense Authorization Act (NDAA) for the Fiscal Year 2019 was passed on August 13, 2018. The law, specifically Section 889, prohibits federal agencies, their contractors, and grant or loan recipients from procuring or using “telecommunications and video surveillance equipment or services” from specific Chinese companies as a “substantial or essential component of any system, or as critical technology as part of any system.” The NDAA ban includes telecommunications equipment produced by Huawei Technologies Company or ZTE Corporation and video surveillance and telecommunications equipment produced by Hytera Communications Corporation, Hangzhou Hikvision Digital Technology Company, or Dahua Technology Company.

## Provision-ISR Statement

With headquarters in Israel and manufacturing facilities located in Shenzhen, China, Provision-ISR supports NDAA-compliance across its product line and is committed to complying with all government and international trade regulations. Provision-ISR is committed to providing NDAA Section 889 compliant products and does not have OEM, ODM, and JDM relationships with the named vendors in the NDAA.

Provision-ISR cameras and network video recorders (NVRs), which do not use or deploy critical components, including SoCs produced by NDAA-banned component vendors, are compliant with the NDAA.

The Provision-ISR compliance product list will be regularly updated on Provision-ISR’s website.

Discover NDAA compliant products



## OSSIA O.S. Operating system

Exercise full control over your video surveillance devices.

Ossia is the latest OS for Provision-ISR's DVR/NVR systems. It is one of the most innovative operating systems available in the market. It offers full compatibility with all Provision-ISR IP cameras with complete control over all main features. Moreover, it provides the user with all the necessary tools to complete the system's utilization while keeping things simple and intuitive. The firmware is based on the most advanced SOC technology and boasts a new graphical user interface (GUI) simple to use, even in comparison to the previous version.



### Main Features

- H.265 Encoding Support\*
- Manual Alarm Output
- Up to 8MP Support\*
- 4K (Ultra HD) Support\*
- Advanced video analysis support (DDA™ VIDEO ANALYTICS, FACE RECOGNITION, PLATES RECOGNITION)\*
- Advanced Network Protocols (QoS, 801.X, HTTPS support , Etc...)
- Scheduled Push Notifications
- E-mail Notifications
- VMS Feature\*
- SNMP Protocol
- Analytics for analog DVR\*
- Fisheye support (only 2 MP NVRs)
- Dual IP configuration
- PoS (Point of sale)
- Support HDD Hibernation and encryption
- 4k output upgraded to 60Hz
- HFR (High Frame Rate)\*

### Key Features



#### Time slice search

Navigate the timeline, click on the available thumbnails and play the video matching your search!



#### Recognition-based playback

There is no need to scroll the timeline to find your "recognition" event: Click on the available thumbnails to find the matching videos!



#### Triggering

Enable a trigger for each type of event: you can choose between push notifications, email, recording, and many more.



#### E-Map

Upload an e-map of your plant, and follow your mark within it!



#### Statistics and reports

How many people have entered your store this week? Enjoy the available DDA™-based statistics!



#### Mass backup abilities

A mass backup can be accomplished by selecting cameras and choosing a specific time slot.



#### Combined alert

Activate a trigger when two different events occur (arming the security system + human detection).

\* only supported model

## VMS - Video Management software

### Feature-rich capabilities for large scale video surveillance



Ossia VMS is an advanced and reliable Video Management Software specifically designed for CCTV systems featuring multiple devices controlled from a single reliable platform.

Centralized monitoring across bank branches, campus facilities, chain stores, or industrial complexes - provides operators with at-a-glance verification of incidents and management of multiple cameras through real-time floor plans and intelligent mapping features.

Ossia VMS solution provides a flexible operational approach for operators and manned guarding teams. With its unique and tailored features, the platform enables a rapid and decisive response to any incident.



#### Main features

- Remote device settings and logs
- Complete live view, including Fish-Eye & PTZ Control, Instant Playback, Audio and Stream Control
- Playback view based on time-slice image, events, or tags
- E-map monitoring
- Face detection and face search capabilities
- Object counting capabilities (Human, 2-wheeled vehicles, and 4-wheeled vehicles)

#### Key Features



##### Face tracking

Upload your own map (or use a Google Map) to track the movements of a suspected individual.



##### TV-Wall management

OSSIA VMS can manage up to 100 video outputs of 144 channels each through a decoder.



##### Triggering

Activate push notifications, emails, recordings, etc., depending on the DDA™ rule you have enabled on your cameras.



##### Audio broadcast

Use your microphone to communicate with all the selected cameras, regardless of their location!



##### Statistics

You can generate statistics or graphs and export them to Excel.



##### Recognition-based playback

Start your search based on face/license plate recognition and play the videos of the matching events!



##### 5 ways to add a device

Choose how you want to add your device! You can do it via IP, P2P(Cloud), DDNS, RTSP, and Auto Report.

## Provision CAM 2 Mobile APP

The app you have always dreamt of is in the pocket of your jeans.

Provision Cam2 is a free application for iOS & Android devices, offering the users complete control over their devices, including live view, playback, and settings. It is compatible with all Provision-ISR NVRs, DVRs, and static IP Cameras. It is secured against unauthorized access, is user-friendly and intuitive for all users.



### Main Features

- Possibility to set your devices directly through the App
- Option to see a mix of live channels or playback channels from different devices on the screen
- 8 different view modes
- A direct P2P connection to the camera (no NVR needed)
- Fisheye/PTZ support
- Possibility to backup recorded files
- Talk and Listen capabilities via supporting devices
- Face database management (face capture, face search)
- Possibility to share the QR code, snapshots, video clips, or problem logs through the most popular App

### Key Features



#### AI-based playback

Search by event: human/vehicle intrusion, human/vehicle line crossing, face recognition, license plate recognition.



#### Face database management

Add and search for faces directly from the App.



#### VR capabilities

Enjoy the ultimate fisheye viewing experience! Move the camera image 360° using your smartphone's gyroscope!



#### Sharing playback as mp4

Get your playback videos in MP4 format for quick sharing!



#### Sharing via QR

Add a device or a specific channel via the App! You can do this in less than a minute by scanning the QR code!



#### Account-based architecture

Your devices will be added to your account and not to your smartphone, allowing you to keep them even when you change your phone, as long as you sign in with the same account.



#### Favorites

Create a group of favorites by adding cameras from multiple devices.



# SHOB Security management platform



## The ultimate parking management experience

Provision-ISR SHOB is a prodigious security management platform that includes a parking management module allowing the user to exercise complete control over the monitored parking areas, from the automated entry of vehicles with registered number plates to the easy registration of visitors in a given time.

When the "SHOB" Security Management Platform meets Provision-ISR LPR cameras, the whole story can be told: the cameras detect and recognize a vehicle license plate and send the information to the "Shob" platform for parking and access management. The user can exercise complete control over the monitored parking areas and efficiently manage various access criteria.



### Main features

- Automated entry of vehicles with registered number plates
- Storage of all incoming/outgoing car images and plate numbers
- Central registration of authorized vehicles or disabled users
- Blacklist warning when an unwanted car appears at the gate
- Easy registration of visitor's vehicles for a given time
- Manual gate opening option from the controller PC

### Key Features



#### Singular operational screen

View real-time captured license plates, manually open a gate, get parking lot status, add authorized vehicles, and more: all in one screen!



#### Reporting

Get a complete report for any selected license plate.



#### Access level management

Assign various access permissions to different vehicles.  
I.e., a visitor can access the visitor parking lot but not the employee parking lot.



#### Favorites

Add Commonly used functions to favorites for faster access.



#### 5 steps and go

Make your system work by using the 5-step LPR quick setup wizard.



#### Visitors

Choose when and for how long a vehicle is permitted to enter your parking lot.



#### Routing vehicles

You can "push" a vehicle to go through predefined paths by opening/closing specific gates inside your parking lot.

## License plate recognition technology

Improve safety and efficiency.



As the world progresses and services become automated, there is a growing request for computerized systems in automotive-related sectors such as gate control, city surveillance, and parking lot management.

LPR (License Plate Recognition) is a game-changing technology at the center of all these solutions.

While recognition errors were common in the past and confirmation by the human eye was always necessary, the license plate recognition cameras we know today are equipped with analytical processors that can guarantee excellent recognition results.



Provision-ISR technology is backed by over 3 years of LPR analytics research and development. The brand-new Smart Plate cameras can provide the best results in various environmental conditions.

Low-light areas, challenging angles, or non-standard characters can cause issues in detecting and capturing license plates.

However, Provision-ISR Smart Plate cameras recognize a much higher number of automobile plates, with much higher efficiency than conventional LPR systems. The Smart Plate Series includes 2MP devices able to capture **two plates per second** and recognize more than **50 international license plates** at **vehicle speeds of up to 40km/h**.

The recognition rate reaches 99% in optimal environmental conditions, and that's why we talk about leading industry accuracy.

### APPLICATION EXAMPLES

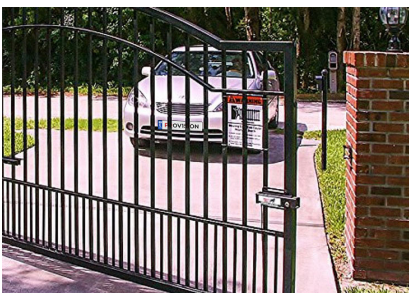

Gate control



Street monitoring and city surveillance



Parking management



# DDA™ VIDEO ANALYTICS

Detect. Distinguish. Alert.



# DDA™

VIDEO ANALYTICS



# The end of false alarms

Machine learning and, in particular, the rapid development of deep learning approaches have revolutionized video analytics. Object Recognition technology consists of using the “experience” gathered in data sets to recognize objects belonging to a particular type, based on specific characteristics typical for that type.

Based on smart object recognition technology, DDA™ VIDEO ANALYTICS allows the system to distinguish between **HUMANS, 4-WHEELED VEHICLES AND 2-WHEELED VEHICLES**. Thanks to this technology, the system triggers alarms or sends push notifications only when the desired object is detected. Doing so reduces annoying false alarms caused by shadows, light changes, shaking trees or animals.

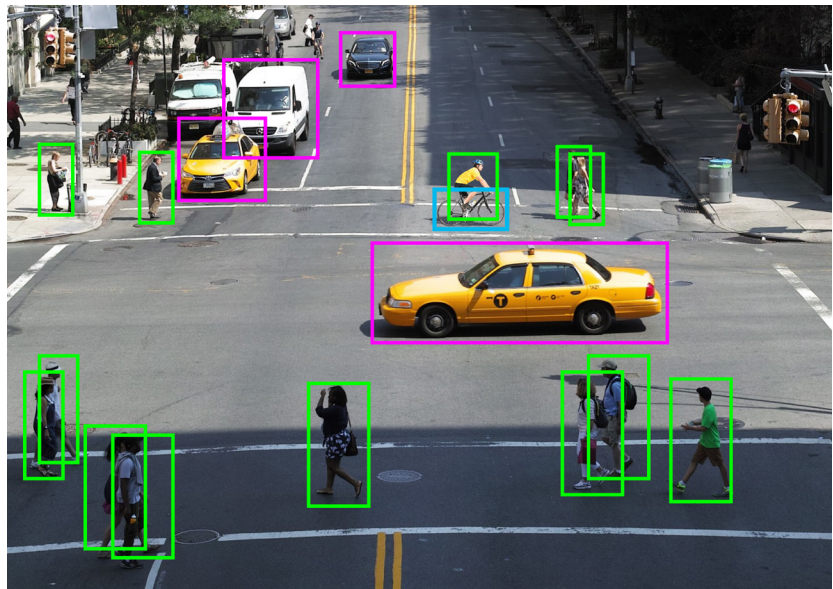

## DDA™ - LINE CROSSING

The user draws a line in the scene and sets access permissions and the crossing direction. When the selected object (human, 2-wheeled vehicle, or 4-wheeled vehicle) crosses the line, the system will trigger an alarm.

### APPLICATION EXAMPLES

- Perimeter protection
- Home/Office/Shop safety
- One-way street monitoring

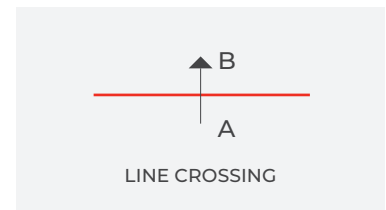

## DDA™ - STERILE AREA

The user draws a virtual area in the scene and sets access permissions. When the selected object (human, 2-wheeled vehicle, or 4-wheeled vehicle) crosses the line, the system will trigger an alarm.

### APPLICATION EXAMPLES

- Emergency exit surveillance
- Pedestrian areas monitoring
- Car dealership monitoring

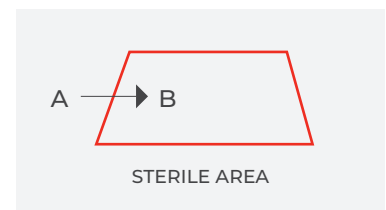

## DDA™ - OBJECT COUNTING

The user draws a line in the scene and sets access permissions and the crossing direction. The counting occurs when the selected object (human, 2-wheeled vehicle, or 4-wheeled vehicle) crosses the line.

### APPLICATION EXAMPLES

- Monitoring the maximum capacity of a building/area
- Vehicles' counting in public and private parking
- Visitors/customers counting for marketing purposes

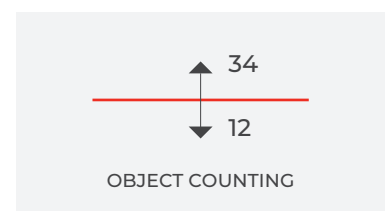



## Face recognition technology

Even a poker face cannot fool us.



Face Recognition technology is based in a field called "biometrics."

We can verify or recognize a person's identity based on physiological characteristics, such as facial features, thanks to biometrics.

Since biometric systems identify a person by biological markers, they are tough to falsify.

Provision-ISR face recognition solutions allow any security manager to quickly identify unauthorized people within a plant and get an immediate notification.

### DYNAMIC FACE DETECTION (Camera Side)

A single camera can detect, trace and evaluate **5-10 faces simultaneously**, depending on the scene conditions.

### FACE RECOGNITION (NVR Side)

The recognition rate reaches 98% if the distance between the pupils is higher than 20 pixels. The NVR face database can store a maximum of **10,000 face** pictures.

The NVR supports different triggers and responses upon detection.

### FACE DATABASE FLEXIBLE MANAGEMENT

- The database can be securely exported and imported to other devices.
- New faces can be **added to the database through the Provision CAM2 Mobile APP.**
- Detected faces can be registered into the face database with a single click.
- The system will mark the more adequate faces for face recognition.

### SEARCH OPTIONS

- Single person / group search
- Possibility to access all the events where a person was recognized.
- **Possibility to search new and existing faces using Cam2 Mobile APP.**
- Quick backup and playback data export.

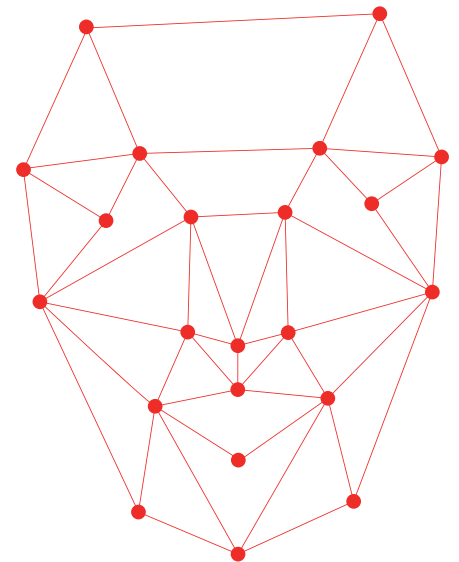

### TRACKING OPTIONS

After uploading an **E-MAP** and positioning all the related cameras over it, you will be able to search for a person. The system will show his track over the map by time order and play the related video playback.

### RECOGNITION STATISTICS

The system offers the user a recognition **statistic chart** by day, week, month, quarter, or any customized period.

### APPLICATION EXAMPLES



Face Greetings

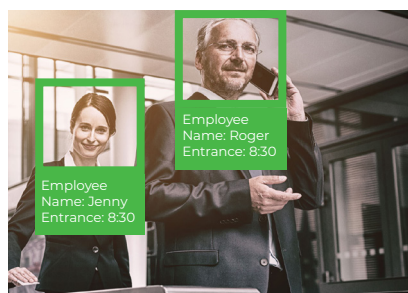

Time & attendance

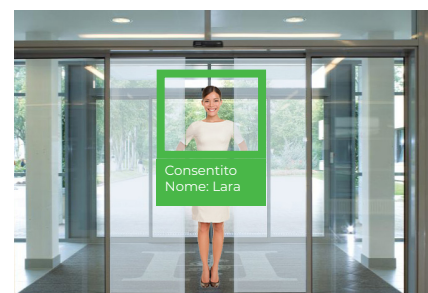

Automated access control



## S-Sight

2MP - 4MP - 8MP

Our S-Sight series provide you with everything you need for a SIMPLE installation.

S-Sight cameras guarantee a superior image quality, improved night performance and make an outstanding value for money solution.



## Eye-Sight

2MP - 4MP - 8MP

Our Eye-Sight series aims at the security professionals seeking a proficient line featuring outstanding image quality, full connectivity, and enhanced video analytics functions based on Artificial Intelligence (DDA™ Video Analytics and Face Recognition).



## Smart-Sight

2MP

Our Smart-Sight series includes high-performance AI cameras designed for specific purposes and applications.

- Smart-Plate - LPR Cameras
- Smart-Face - Face Recognition Cameras
- Smart-Alert - Active Deterrence Cameras

All the components, beginning with the sensor, optics, CPU, and lighting, were specially selected to deliver the most accurate AI results for the required application.



## Rainbow

2MP - 4MP

Provision-ISR's rainbow cameras, equipped with CNV (Color Night Vision) technology, return sharp and superior quality colors even in poor light conditions, providing visual details that significantly contribute to identifying people and objects.

Provision-ISR IP range also includes:

- A series of **PTZ cameras** for wide-area coverage.
- A series of **special cameras** specifically designed for non-conventional applications (Fisheye, hidden and PIR cameras).

## Comparison based on main and video analytics features

		S- Sight	Eye-Sight	Smart-Sight	Rainbow
Resolution	2MP	●	●	●	●
	4MP	●	●		●
	5MP				
	8MP	●	●		
Video Compression	H265	H265 SMART	H265 SMART	H265	
SD card	●	●	●	●	
WDR	Digital	TRUE	TRUE	Digital	
Star light sensor*	-	●	-	-	
Full color	-	-	-	●	
Artificial Intelligence	-	●	●	●	
Alarm*	-	●	●	-	
Audio*	●	●	●	●	
Built In Mic*	●	●	●	●	

		S- Sight	Eye-Sight	Smart-Sight	Rainbow
General video analytics	Camera tampering	●	●	●	●
	Smart search	●	●	●	●
Standard video analytics	Line crossing	●			
	Sterile area	●			
Artificial Intelligence	DDA™				
	Line crossing*		●		●
	DDA™				
	Sterile area*		●		●
	DDA™				
	Object counting*		●		●
Face detection		●			
License Plate recognition				●	

\* only supported model

# IP Cameras

## Model name index

### Bullet / Dome / Turret

Example	D	I	3	2	0	IPSN	VF	G	
	I	4	3	2	0	IPSN	VF		
	Category		CMOS		LUX		Lens		
B	Body		2	~ 1/2"	0	0 (IR on)		28	2.8mm
D	Dome		3	~ 1/3"	1	Below ~ 0.009		36	3.6mm
FE	Fish-Eye				2	0.01 ~ 0.1		37	3.7mm
I	Infra Red (IR) Bullet							43	4.3mm
M	Mini							VF	Vari-focal
D	Dome							MVF	Motorized VF (auto focus)
T	Tube								
	Sub-Category		Resolution		Solution		Color		
X	No sub-category		2	2 MP	IPS	S-Sight (V2)		G	Grey
AI	Anti vandal (IR)		3	3 MP	IPE	Eye-Sight (V2)			
C	Pinhole cone shape		4	4 MP	IP5	H.265			
I	Infra red (IR)		8	8 MP	WIP5	H.265 Wifi			
MA	Mini Anti Vandal				IPSN	Novatek			
PT	Pan/Tilt				IPSR	Rainbow S-Sight			
2	IR 20 m				IPERN	Rainbow Eye-Sight			
3	IR 30 m								
4	IR 40 m								
6	IR 60 m								
L	Light								

### Bullet PTZ

Example	I5	PT	3	2	0	IPM	X4	P
	I5	PT	3	2	0	IPM	X10	P
IR Distance	Category	CMOS	Resolution	LUX	Solution	Zoom	Special features	
I5   50 m	PT   Pan Tilt	3   ~ 1/3"	2   2 MP	0   0 (IR on)	IP   IP	X4   x4 zoom	P   POE	
I10   100 m			3   3 MP		IPM   MStar	X10   x10 zoom		
			4   4 MP			X20   x20 zoom		

### Speed dome

Example	MZ	20	IP	2	(IR)
	Z6	32	IPE	4	(IR)
Category	Lens	Solution	Resolution	Special features	
Z	Speed dome	IP/IPE   IP	2   2 MP	(IR)   Infra Red	
MZ	Mini Speed dome	IPM   MStar	3   3 MP		
			4   4 MP		



S-Sight cameras **2 MP**



**Features:** 25/30 fps, H.265, up to 128Gb SD card, Digital WDR, 3D-DNR, BLC, HLC, ROI, Privacy mask, Motion detection, 2 streams, IP 67, Power supply DC12V/PoE.

General video analytics: Camera tampering, Smart search.

Standard video analytics: Line crossing, Sterile Area.



DI-320IPSN-28 | DI-320IPSN-28-G



DI-320IPSN-36



DI-320IPSN-VF  
DI-320IPSN-VF-G



Lens	2.8mm (107°)	3.6mm (87.3°)	2.8-12mm Vari-Focal (88°-34.8°)
IR Distance	20m (1 High Power IR LED)	20m (1 High Power IR LED)	40m (3 High Power IR LED)
Audio	Built-In Microphone	Built-In Microphone	Built-In Microphone
Power supply	DC12V/~400mA / PoE/~5.2W	DC12V/~420mA / PoE/~5.4W	DC12V/~900mA / PoE/~10W
Brackets/junction box	G	G	F

I2-320IPSN-28



I2-320IPSN-36



I4-320IPSN-VF



Lens	2.8mm (107°)	3.6mm (87.3°)	2.8-12mm Vari-Focal (94°-35.7°)
IR Distance	20m (1 High Power IR LED)	20m (1 High Power IR LED)	40m (2 High Power IR LED)
Audio	-	-	-
Power supply	DC12V/~420mA / PoE/~5.4W	DC12V/~420mA / PoE/~5.4W	DC12V/~780mA / PoE/~7.4W
Brackets/junction box	A	A	B



## S-Sight cameras 4 MP



**Features:** 25/30 fps, H.265, Up to 128Gb SD card, Digital WDR, 3D-DNR, BLC, HLC, ROI, Privacy mask, Motion detection, 2 streams, IP 67, Power supply DC12V/POE.  
 General video analytics: Camera tampering, Smart search.  
 Standard video analytics: Line crossing, Sterile Area.





	DI-340IPS-28   DI-340IPS-28-G	DI-340IPS-36	DI-340IPS-MVF   DI-340IPS-MVF-G
			
<b>Lens</b>	2.8mm (110°)	3.6mm (89°)	2.8-12mm Motorized Vari-Focal with Auto Focus (94°-35.7°)
<b>IR Distance</b>	20m (1 High Power IR LED)	20m (1 High Power IR LED)	40m (3 High Power IR LED)
<b>Audio</b>	Built-In Microphone	Built-In Microphone	Built-In Microphone
<b>Power supply</b>	DC12V/~400mA / PoE/~5.2W	DC12V/~400mA / PoE/~5.2W	DC12V/~900mA / PoE/~10W
<b>Brackets/junction box</b>	G	G	F

	I2-340IPS-28	I2-340IPS-36	I4-340IPS-MVF
			
<b>Lens</b>	2.8mm (110°)	3.6mm (89°)	2.8-12mm Motorized Vari-Focal with Auto Focus (94°-35.7°)
<b>IR Distance</b>	20m (1 High Power IR LED)	20m (1 High Power IR LED)	40m (2 High Power IR LED)
<b>Audio</b>	-	-	-
<b>Power supply</b>	DC12V/~420mA / PoE/~5.4W	DC12V/~420mA / PoE/~5.4W	DC12V/~780mA / PoE/~7.4W
<b>Brackets/junction box</b>	A	A	B

## S-Sight cameras 8 MP



**Features:** 25/30 fps, H.265, up to 128Gb SD card, Digital WDR, 3D-DNR, BLC, HLC, ROI, Privacy mask, Motion detection, 2 streams, IP 67, Power supply DC12V/POE.  
 General video analytics: Camera tampering, Smart search.  
 Standard video analytics: Line crossing, Sterile Area.

	DI-380IPS-28	DI-380IPS-MVF	I4-380IPS-28	I4-380IPS-MVF
				
<b>Lens</b>	2.8mm (112°)	2.8-12mm Motorized Vari-Focal with Auto Focus (102.7°- 32.2°)	2.8mm (112°)	2.8-12mm Motorized Vari-Focal with Auto Focus (102.7°- 32.2°)
<b>IR Distance</b>	20m (1 High Power IR LED)	40m (3 High Power IR LED)	40m (2 High Power IR LED)	40m (2 High Power IR LED)
<b>Audio</b>	Built-In Microphone + 1 IN	Built-In Microphone + 1 IN	1 IN	1 IN
<b>Power supply</b>	DC12V/~400mA / PoE/~5.2W	DC12V/~900mA / PoE/~10W	DC12V/~420mA / PoE/~5.4W	DC12V/~780mA / PoE/~7.4W
<b>Brackets/junction box</b>	G	F	B	B







Eye-Sight cameras 2 MP



**Features:** 25/30 fps, H.265, up to 128Gb SD card, True WDR, 3D-DNR, BLC, HLC, ROI, Privacy mask, Motion detection, 3 streams, IP 67, Power supply DC12V/POE.

General video analytics: Camera tampering, Smart search.

Artificial intelligence: DDA™ Line crossing, DDA™ Sterile area, DDA™ Object counting, Face detection.

	DAI-320IPE-28	DAI-320IPE-MVF	DI-320IPE-28	DI-320IPE-MVF
				
<b>Lens</b>	2.8mm (108°)	2.8-12mm Motorized Vari-Focal with Auto Focus (103°-32°)	2.8mm (108°)	2.8-12mm Motorized Vari-Focal with Auto Focus (103°-32°)
<b>IR Distance</b>	20m (3 High Power IR LED)	40m (2 High Power IR LED)	20m (1 High Power IR LED)	40m (3 High Power IR LED)
<b>Audio</b>	Built-In Microphone + 1 IN	Built-In Microphone + 1 IN + 1 OUT	Built-In Microphone + 1 IN	Built-In Microphone + 1 IN
<b>Alarm</b>	1 IN + 1 OUT	1 IN + 1 OUT	-	-
<b>Power supply</b>	DC12V/~620mA / PoE/~6.3W	DC12V/~780mA / PoE/~7.4W	DC12V/~400mA / PoE/~5.2W	DC12V/~900mA / PoE/~10W
<b>Brackets/junction box</b>	I	H	G	F

	DMA-320IPE-28	I4-320IPE-36	I4-320IPE-MVF	I6-320IPE-MVF
				
<b>Lens</b>	2.8mm (108°)	3.6mm (89°)	2.8-12mm Motorized Vari-Focal with Auto Focus (103°-32°)	2.8-12mm Motorized Vari-Focal with Auto Focus (103°-32°)
<b>IR distance</b>	10m (2 High Power IR LED)	40m (2 High Power IR LED)	40m (2 High Power IR LED)	60m (4 High Power IR LED)
<b>Audio</b>	Built-In Microphone + 1 IN	1 IN	1 IN	1 IN + 1 OUT
<b>Alarm</b>	-	-	-	1 IN + 1 OUT
<b>Power supply</b>	DC12V/~340mA / PoE/~4.7W	DC12V/~780mA / PoE/~7.4W	DC12V/~780mA / PoE/~7.4W	DC12V/~910mA / PoE/~8.2W
<b>Brackets/junction box</b>	E	B	B	C

## Eye-Sight cameras 4 MP



**Features:** 25/30 fps, H.265, up to 128Gb SD card, True WDR, 3D-DNR, BLC, HLC, ROI, Privacy mask, Motion detection, 3 streams, IP 67, Power supply DC12V/POE.  
 General video analytics: Camera tampering, Smart search.  
 Artificial intelligence: DDA™ Line crossing, DDA™ Sterile area, DDA™ Object counting, Face detection.

	DAI-340IPE-28	DAI-340IPE-MVF	DI-340IPE-28   DI-340IPE-28-G	DI-340IPE-MVF
				
<b>Lens</b>	2.8mm (100°)	2.8-12mm Motorized Vari-Focal with Auto Focus (94.3°-29.9°)	2.8mm (100°)	2.8-12mm Motorized Vari-Focal with Auto Focus (94.3°-29.9°)
<b>IR Distance</b>	20m (3 High Power IR LED)	40m (2 High Power IR LED)	20m (1 High Power IR LED)	40m (3 High Power IR LED)
<b>Audio</b>	Built-In Microphone + 1 IN	Built-In Microphone + 1 IN + 1 OUT	Built-In Microphone + 1 IN	Built-In Microphone + 1 IN
<b>Alarm</b>	1 IN + 1 OUT	1 IN + 1 OUT	-	-
<b>Power supply</b>	DC12V/~620mA / PoE/~6.3W	DC12V/~780mA / PoE/~7.4W	DC12V/~400mA / PoE/~5.2W	DC12V/~900mA / PoE/~10W
<b>Brackets/junction box</b>	I	H	G	F

	DMA-340IPE-28	I4-340IPE-36	I4-340IPE-MVF	I6-340IPE-MVF
				
<b>Lens</b>	2.8mm (100°)	3.6mm (80.6°)	2.8-12mm Motorized Vari-Focal with Auto Focus (94.3°-29.9°)	2.8-12mm Motorized Vari-Focal with Auto Focus (94.3°-29.9°)
<b>IR Distance</b>	10m (2 High Power IR LED)	40m (2 High Power IR LED)	40m (2 High Power IR LED)	60m (4 High Power IR LED)
<b>Audio</b>	Built-In Microphone + 1 IN	1 IN	1 IN	1 IN + 1 OUT
<b>Alarm</b>	-	-	-	1 IN + 1 OUT
<b>Power supply</b>	DC12V/~340mA / PoE/~4.7W	DC12V/~780mA / PoE/~7.4W	DC12V/~780mA / PoE/~7.4W	DC12V/~910mA / PoE/~8.2W
<b>Brackets/junction box</b>	E	B	B	C

## Eye-Sight cameras 8 MP



**Features:** 25/30 fps, H.265S/H265+, up to 128Gb SD card, True WDR, 3D-DNR, BLC, HLC, ROI, Privacy mask, Motion detection, 3 streams, IP 67, Power supply DC12V/POE.  
 General video analytics: Camera tampering, Smart search.  
 Artificial intelligence: DDA™ Line crossing, DDA™ Sterile area, DDA™ Object counting, Face detection.

	DAI-380IPE-MVF	DI-380IPE-MVF	I6-380IPE-MVF
			
<b>Lens</b>	2.8-12mm Motorized Vari-Focal with Auto Focus (96°- 32°)	2.8-12mm Motorized Vari-Focal with Auto Focus (96°- 32°)	2.8-12mm Motorized Vari-Focal with Auto Focus (96°- 32°)
<b>IR Distance</b>	40m (2 High Power IR LED)	40m (3 High Power IR LED)	60m (4 High Power IR LED)
<b>Audio</b>	Built-In Microphone + 1 IN + 1 OUT	Built-In Microphone + 1 IN	1 IN + 1 OUT
<b>Alarm</b>	1 IN + 1 OUT	-	1 IN + 1 OUT
<b>Power supply</b>	DC12V/~780mA / PoE/~7.4W	DC12V/~910mA / PoE/~8.2W	DC12V/~910mA / PoE/~8.2W
<b>Brackets/junction box</b>	H	F	C



Smart-Sight LPR cameras **2 MP**



**Features:** 25/30 fps, H.265S/H265+, up to 128Gb SD card, 32 Gb internal storage, True WDR, 3D-DNR, BLC, HLC, ROI, Privacy mask, Motion detection, 3 streams, IP 67, Power supply DC12V/POE.  
 General video analytics: Camera tampering, Smart search.  
 Artificial intelligence: License plate recognition.

I6-320LPR-MVF1

I6-320LPR-MVF2



Lens	2.8-12mm MVF(103.4°-32.4°)	7-22mm MVF (44°-17.6°)
IR Distance	60m (4 High Power IR LED)	60m (4 High Power IR LED)
Audio	1 IN + 1 OUT	1 IN + 1 OUT
Alarm	1 IN + 1 OUT	1 IN + 1 OUT
Power supply	DC12V/~910mA / PoE/~11W	DC12V/~910mA / PoE/~11W
Brackets/junction box	C	C



## Smart-Sight Face recognition cameras 2 MP



**Features:** 25/30 fps, H.265S/H265+, up to 128Gb SD card, True WDR, 3D-DNR, BLC, HLC, ROI, Privacy mask, Motion detection, 2 streams, IP 67 (only DW-320FR-MVF2 and TW-320FR-MVF2), Power supply DC12V/POE.  
 General video analytics: Camera tampering, Smart search.  
 Artificial intelligence: Face recognition.

	BX-321FR	DW-320FR-MVF2	TW-320FR-MVF2
			
<b>Lens</b>	CS MOUNT	7-22mm MVF with Auto Focus (44°-17.6°)	7-22mm MVF with Auto Focus (44°-17.6°)
<b>IR Distance</b>	-	10m white led light	0m white led light
<b>Audio</b>	Two-way Audio	One-way Audio	Two-way audio
<b>Alarm</b>	2 Alarm in + 2 Alarm Out	-	Alarm in + Alarm Out
<b>Power supply</b>	DC12V~320mA / AC24V~160mA / PoE~6W	DC12V~320mA / AC24V~160mA / PoE~6W	DC12V~320mA / AC24V~160mA / PoE~6W
<b>Brackets/junction box</b>	-	F	F

## Provision-ISR's active deterrence cameras

Unlike “standard” security cameras, which are commonly used to investigate an event after it happened, active deterrence cameras notify the intruder that his presence has been detected and drive him out of the premises. For this reason, they can be compared to real alarm systems.

Provision-ISR's Smart Alert cameras integrate active deterrence mechanisms (such as flashlight and speaker) into compact security devices. Provision-ISR enhances the cameras' performance by enriching them with advanced artificial intelligence (DDA Video Analytics – Object Recognition Technology).

Available in the Turret / Dome and bullet versions, Provision-ISR's Smart Alert cameras include more exciting features such as the possibility to upload a customized audio message.

Provision-ISR's active deterrence cameras are widely used in private properties' perimeter protection, industrial or commercial areas. They are also used to prevent unauthorized access to restricted areas, parking lots, or pedestrian zones.

Let Provision-ISR's Smart Alert cameras be your security guard!



Coming soon

**SMART ALERT**  
 ACTIVE DETERRENCE CAMERAS



Rainbow cameras **2 MP**



**Features:** 25/30 fps, H.265, up to 128Gb SD card, Digital WDR, BLC, HLC, ROI, 3D-DNR, Privacy mask, Motion detection, 2 streams, IP 67, Power supply DC12V/POE.  
**General video analytics:** Camera tampering  
**Standard video analytics:** Line crossing, Sterile Area.



**NEW**

**DL-320IPSR-36**



**NEW**

**TL-320IPSR-36**



Lens	3.6mm (84.8°)	3.6mm (84.8°)
IR Distance	25m (2 High Power White LED)	25m (2 High Power White LED)
Audio	Built-In Microphone	-
Power supply	DC12V/~420mA / PoE/~5.4W	DC12V/~780mA / PoE/~7.4W
Brackets/junction box	G	B

Rainbow cameras **4 MP**



**Features:** 25/30 fps, H.265, up to 128Gb SD card, True WDR, BLC, HLC, ROI, 3D-DNR, Privacy mask, Motion detection, 3 streams, IP 67, Power supply DC12V/POE.  
**General video analytics:** Camera tampering  
**Artificial intelligence:** DDA™ Line crossing, DDA™ Sterile Area, DDA™ Object counting and Face detection.



**NEW**

**DL-340IPERN-36**



**NEW**

**TL-340IPERN-36**



Lens	3.6mm (84.8°)	3.6mm (84.8°)
IR Distance	25m (2 High Power White LED)	25m (2 High Power White LED)
Audio	Built-In Microphone + 1 IN	1 IN
Power supply	DC12V/~400mA / PoE/~5.2W	DC12V/~780mA / PoE/~7.4W
Brackets/junction box	G	B

## Don't lose sight of your target



### Intelligent Auto-Tracking PTZ **2 MP**



**Features:** 25/30 fps, H.265, 300 Preset Position, Park Action, 4 Pattern, Scan Route and 8 Cruise Lanes , up to 256Gb SD card, Digital WDR, BLC, HLC, 3D-DNR, Privacy mask, Motion detection, 3 streams, IP 67.

General video analytics: Camera tampering

Artificial intelligence: DDA™ Line crossing, DDA™ Sterile Area, DDA™ Object counting and Face detection.



**NEW**

Z4-25IPE-2(IR)



**NEW**

Z5-25IPE-2(IR)



	Z4-25IPE-2(IR)	Z5-25IPE-2(IR)
Lens	<b>x 25</b> 4.8mm (F1.65) - 120mm (F3.8)	<b>x 25</b> 4.8mm (F1.65) - 120mm (F3.8)
Pan/Tilt range	360° (Endless) / 180° (Auto Flip)	360° (Endless) / 180° (Auto Flip)
IR Distance	Smart IR 100 m	Smart IR 100 m
Smart tracking	Auto Tracking based on DDA™ (Human / Vehicle)	Auto Tracking based on DDA™ (Human / Vehicle)
Audio	-	1 IN - 1 OUT
Alarm	-	1 IN - 1 OUT
Brackets/junction box*	L	L

### Intelligent auto-tracking PTZ **4 MP**



**Features:** 25/30 fps, H.265, 300 Preset Position, Park Action, 4 Pattern, Scan Route and 8 Cruise Lanes , up to 256Gb SD card, Digital WDR, BLC, HLC, 3D-DNR, Privacy mask, Motion detection, 3 streams, IP 67.

General video analytics: Camera tampering

Artificial intelligence: DDA™ Line crossing, DDA™ Sterile Area, DDA™ Object counting and Face detection.



**NEW**

Z4-25IPE-4(IR)



**NEW**

Z5-25IPE-4(IR)



**NEW**

Z6-32IPE-4(IR)



	Z4-25IPE-4(IR)	Z5-25IPE-4(IR)	Z6-32IPE-4(IR)
Ottica	<b>x 25</b> 4.8mm (F1.65) - 120mm (F3.8)	<b>x 25</b> 4.8mm (F1.65) - 120mm (F3.8)	<b>x 32</b> 5.6mm (F1.55) - 179.2mm (F3.4)
Pan/Tilt range	360° (Endless) / 180° (Auto Flip)	360° (Endless) / 180° (Auto Flip)	360° (Endless) / 220° (Continuous)
IR Distance	Smart IR 100 m	Smart IR 100 m	Smart IR 150 m
Smart tracking	Auto Tracking based on DDA™ (Human / Vehicle)	Auto Tracking based on DDA™ (Human / Vehicle)	Auto Tracking based on DDA™ (Human / Vehicle)
Audio	-	1 IN - 1 OUT	1 IN - 1 OUT
Allarmi	-	1 IN - 1 OUT	2 IN - 2 OUT
Brackets/junction box*	L	L	L

## IP PTZ cameras

Features: Digital WDR, privacy mask, ICR, noise reduction, motion detection, IP66.

	I5PT-320IPMX4-P	I5PT-320IPMX10-P	MZ-20IPM-2(IR)
			
Resolution	2MP	2MP	2MP
Lens	x4 (2.8-12mm)	x10 (5,1-51 mm)	x20 (F1.6~4.9mm - F3.5~98mm)
Pan/Tilt range	250° Pan / 65° Tilt	250° Pan Rotation 65° Continuous Tilt	360° (Endless) / 0°~180° (Auto Flip)
IR Distance	50 m	50 m	80 m
Auto tracking	-	-	-
Audio	-	-	-
Alarm	-	-	-
Power supply	DC12V/2A (Not supplied) PoE(~10W)	DC12V/2A (Not supplied) PoE(~10W)	12v/3A
Brackets/junction box	-	-	pag 47

## IP Special cameras

Features: 25/30 fps, H.265, up to 128Gb SD card, Digital WDR, 3D-DNR, BLC, HLC, ROI, Privacy mask, Motion detection.

General video analytics: Camera tampering, Smart search. (only IV-320IP-37)

	MC-392IP543	FEI-360IP5-V2	IV-320IP-37	BX-341IPE	
					
Resolution	2 MP	6 MP	2 MP	4 MP	
Lens	4,3 mm (62°)	1.07 mm (360° ceiling - 180° wall)	3,7mm	CS Mount	
IR Distance	-	15 m (6 High power IR LED)	10m (20 Invisible IR LED)	-	
Audio	Built-In Microphone	Built-In Microphone + 1 IN + 1 OUT	Built-In Microphone + 1 IN	1 IN - 1 OUT	
Alarm	-	1 IN - 1 OUT	-	2 IN - 2 OUT	
Power supply	DC12V-150mA	DC12V-300mA / PoE-3W	DC12V/~420mA / PoE/~4.8W	DC12V~320mA / AC24V~160mA / PoE~6W	
Brackets/junction box	-	PR-B50JB	-	-	

## IP Wireless cameras

Features: Image sensor 1/3", H.265, Digital WDR, 3D-DNR, Motion detection, IP66, Power supply DC12V.

Need receiver WR-04IPC-V2.

	I3-330WIP536-M	WR-04IPC-V2
		
Resolution	3 MP	4 wireless IPC
Lens	3.6mm (90°)	1 x RJ45 100Mbps network interface
IR Distance	30m (3 High Power IR LED)	1 x Match/Reset button
Power supply	DC12V/~520mA	1 x 12V Alimentazione
Brackets/junction box	PR-JB12IP64 - PR-JB12IP66	186mm×74mm×31mm



# NVR

## Network Video Recorders



In standard installations - the NVR is the heart of the IP System.

It is responsible for smooth communication with the cameras and the constant recording of all the data received from the connected cameras. Unlike DVRs, the NVR doesn't compress the video signal received from the IP camera but only stores it the same way as the camera already compresses it.

### CONVENTIONAL NVRs

These NVRs are connected to the network and communicate with the IP cameras through the general network, without a direct IP camera connection. This provides the installer **the highest flexibility in the design of the system and the wiring.**

Basic knowledge in networking and general IP configuration is required.

### POE NVRs

These NVRs perform as a local network switch by creating a closed internal network for the IP cameras. **The IP cameras are connected directly to the NVR by one network cable which will provide PoE power** and automatically configure the camera for display & record.

These NVRs may also perform as conventional NVRs by dedicating some channels to communicating with any ONVIF camera connected to the network. No previous knowledge is required for this type of installation.

### Model name index

	Resolution	n° channels	total FPS	Special feat.	Case
example	NVR5	8	200	PX	MM
	NVR8	16	400	FA	1U



Resolution		n° channels		Special features	
NVR5	5MP real time	4	4 Channels	X	Economy series
NVR8	8MP real time	8	8 Channels	P	PoE support
		16	16 Channels	E	H.264 Economy series
		32	32 Channels	F	AI-Based analytics
		64	64 Channels	A	Alarm
		128	128 Channels	R	RAID support
				T	Real time

Total FPS		Case	
50	50 fps (PAL) / 60 fps (NTSC)	"none"	Small 1U case 1HDD support
100	100 fps (PAL) / 120 fps (NTSC)	MM	mini metal case 1HDD support
200	200 fps (PAL) / 240 fps (NTSC)	1U	1U case 2HDD support
400	400 fps (PAL) / 480 fps (NTSC)	1.5U	1.5U case 4HDD support
800	800 fps (PAL) / 960 fps (NTSC)	2U	2U case 8HDD support
1600	1600 fps (PAL) / 1920 fps (NTSC)	3U	3U case 16HDD support





## NVR 4 Ch

Features: H.265, Backup format AVI/DAT, VMS support, Video Analytics Support, AI support (DDA™, LPR), Provision Cam2 APP, Cloud APP & Web page connection.

	NVR5-4100X+(MM)	NVR5-4100PX+(MM)
	 	
Resolution	5 MP	5 MP
Video output	HDMI: 1080P VGA: 1280X1024	HDMI: 1080P VGA: 1280X1024
Max. Recording	4CH 5MP Real Time	4CH 5MP Real Time
Alarm	-	-
Audio	-	-
Hard Disk	1 SATA (6 TB Max)	1 SATA (6 TB Max)
Power supply	DC12V-2A	DC48V/1.04A
Dimensions	255x220x45mm	255x220x45mm

## NVR 8 Ch





Features: H.265, Backup format AVI/DAT, VMS support, Video Analytics Support, AI support (DDA™, LPR), Provision Cam2 APP, Cloud APP & Web page connection.

	NVR5-8200X+(MM)	NVR5-8200PX+(MM)	4K NVR8-8200FA	4K NVR8-8200PFA
	 			
Resolution	5 MP	5 MP	8 MP	8 MP
Video output	HDMI: 1080P VGA: 1280X1024	HDMI: 1080P VGA: 1280X1024	HDMI: 4K VGA: 1280X1024	HDMI: 4K VGA: 1280X1024
Max. Recording	8CH 5MP Real Time	8CH 5MP Real Time	8CH 8MP Real Time	8CH 8MP Real Time
Alarm	-	-	8 IN / 4 OUT	8 IN / 4 OUT
Audio	-	-	1 IN / 1 OUT	1 IN / 1 OUT
Hard Disk	1 SATA (6 TB Max)	1 SATA (6 TB Max)	1 SATA (8 TB Max)	1 SATA (8 TB Max)
Power supply	DC12V-2A	DC48V-2.5A	DC48V/2.5A	DC48V/2.5A
Dimensions	255x220x45mm	255x220x45mm	375x275x50mm	375x275x50mm

## NVR 16 Ch







Features: H.265, Backup format AVI/DAT, VMS support, Video Analytics Support, AI support (DDA™, LPR), Provision Cam2 APP, Cloud APP & Web page connection.

	NVR8-16400A(1U)	NVR8-16400FA(1U)	NVR8-16400PFA(1U)
	 		
Resolution	8 MP	8 MP	8 MP
Video output	HDMI: 4K VGA: 1280X1024	HDMI: 4K VGA: 1280X1024	HDMI: 4K VGA: 1280X1024
Max. Recording	16CH 8MP Real Time	16CH 8MP Real Time	16CH 8MP Real Time
Alarm	4 IN / 1 OUT	8 IN / 4 OUT	8 IN / 4 OUT
Audio	1 IN / 1 OUT	1 IN / 1 OUT	1 IN / 1 OUT
Hard Disk	2 SATA (8TB each)	2 SATA (8TB each)	2 SATA (8TB each)
Power supply	DC12V-3A	DC12V-4A	AC100-240V
Dimensions	375X275X50mm	375X275X45mm	430x390x70mm

Fisheye Support: NVR8-8200FA, NVR8-8200PFA, NVR8-16400FA (1U), NVR8-16400PFA(1U).



**NVR 32 Ch** 4K

**Features:** H.265, Backup format AVI/DAT, VMS support, Video Analytics Support, AI support (DDA™, LPR), Provision Cam2 APP, Cloud APP & Web page connection.

	<b>NEW</b> NVR8-32800F(1U) NVR8-32800FA(1U)	NVR8-32800RFA(2U)	NVR8-32800F-16P(2U)
	 		
<b>Resolution</b>	8 MP		
<b>Video output</b>	HDMI1: 4K VGA: 1080P		
<b>Max. Recording</b>	16CH 8MP Real Time		
<b>Alarm</b>	-	8 IN / 4 OUT	
<b>Audio</b>	1 IN / 1 OUT		
<b>Hard Disk</b>	2 SATA (8TB each)		
<b>Power supply</b>	DC12V-4A		
<b>Dimensions</b>	375X375X45mm		



**NVR 64 Ch** 4K

**Features:** H.265, Backup format AVI/DAT, VMS support, Video Analytics Support, AI support (DDA™, LPR), Provision Cam2 APP, Cloud APP & Web page connection.

	NVR8-641600R(2U)
	 
<b>Resolution</b>	8 MP
<b>Video output</b>	HDMI1: 4K HDMI2+VGA: 1080P
<b>Max. Recording</b>	64CH 8MP Real Time
<b>Alarm</b>	8 IN / 4 OUT
<b>Audio</b>	1 IN / 1 OUT
<b>Hard Disk</b>	8 SATA (8TB each) 2 ESata Port
<b>Power supply</b>	AC100-240V
<b>Dimensions</b>	430X445X97mm

**NVR 128 Ch** 4K

**Features:** H.265, Backup format AVI/DAT, VMS support, Video Analytics Support, AI support (DDA™, LPR), Provision Cam2 APP, Cloud APP & Web page connection.

	NVR8-128RT(3U)
	 
<b>Resolution</b>	8 MP
<b>Video output</b>	HDMI1: 4K HDMI2+VGA: 1080P
<b>Max. Recording</b>	128CH 8MP Real Time
<b>Alarm</b>	8 IN / 4 OUT
<b>Audio</b>	1 IN / 1 OUT
<b>Hard Disk</b>	16 SATA (8TB each) 2 ESata Port
<b>Power supply</b>	AC100-240V
<b>Dimensions</b>	440X485X148mm

Fisheye Support: NVR8-32800F(1U), NVR8-32800RFA(2U), NVR8-32800F-16P(2U), NVR8-641600R(2U), NVR8-128RT(3U).

# IP

## Switch POE

### STANDARD 10/100 Mbps

These PoE switches are the best choice for any standard installation.

They are designed specifically for IP surveillance giving extra reliability and installation simplicity.

With 4/8/16/24 port options, standard uplinks, and SFP ports (depending on model), they aid with finding a solution for any installation.

### PROFESSIONAL 10/100/1000 MBPS

The 1000Mbps (gigabit) PoE switches are made for true professionals. The professional 16/24 Port switches, equipped with an LCD monitor, were designed to display all the following PoE system information on the front panel of the device:

- Single channel In/Out power (W)
- Overload (OLP)
- Short circuit (SCP)
- Low voltage / over voltage (alarm)
- High temperature (alarm)

### KEEP ALIVE FUNCTION\*

You can configure the new switch series to monitor connected PD's status in real-time via traffic detection.

Once traffic of an active port stops for a set duration, the switch will automatically restart the PoE port power, causing the PD to reboot and bring it back to a working state.

This feature will significantly enhance reliability and reduce administrator management burden.

### CCTV MODE

The CCTV mode is actually a preconfigured VLAN (Cannot be customized by the user) that prevents all communication among the downlink ports. The CCTV mode also limits the communication to 10Mbps to increase stability.

The achieved benefits of CCTV mode are: No communication among downlink ports (VLAN) - improves the network security and data transmission efficiency.

Limiting the communication speed to 10Mbps increases the communication distance to a maximum of 250 meters.

### LCD Switch PoE

An intuitive color panel placed on the front of the switch facilitates Ethernet management and PoE PD management. Smart and intuitive LCD control, jolts for efficient management in large-scale networks for enterprises, hotels, shopping malls, government buildings, and other public areas, and features some specific management and status functions (PoE/Port management and status, switch mode, budget and bandwidth control, PD alive check, maintenance).

### PoE Accessories

#### PoESP-0124W SPLITTER ETHERNET 1 CH POE

- Adjustable output: 5VDC/2A, 9VDC/2A o 12VDC/2A
- Maximum Power Output: Up To 24W
- Short-Circuit Protection
- High Efficiency DC/DC Converter



#### PoESP-0172W SPLITTER ETHERNET 1 CH POE

- Output: 24VDC / 3A
- Maximum Power Output: Up To 72W
- Short-Circuit Protection
- High Efficiency DC/DC Converter
- DC Jack / Terminal Connector Output



#### PoEI-0130 / PoEI-0160 ETHERNET INJECTOR 1 CH POE

- Downlink: 1x 100 Mbps
- Output: PoEI-0130 max 30W - PoEI-0160 max 60W
- Internal power supply (require 110/220AC input)
- Distance: up to 100 Meters
- Built-in surge protection



#### PoER-01 EXTENDER (REPEATER) 1 CH POE

- Extends PoE Ethernet range up to additional 100 meters (10/100Mbps Ethernet)
- No additional power supply is required
- Automatically detects and protects PoE equipment from being damaged by incorrect installation



#### PoER-02 EXTENDER (REPEATER) 1 TO 2 CH POE

- Extends PoE range up to additional 150 Meters (10/100Mbps Ethernet)
- 11 ch Input / 2 Ch Output
- No additional power supply is required
- Automatically detects and protects PoE equipment from being damaged by incorrect installation



#### DCoE-01 NON-POE POWER OVER ETHERNET CONVERTER

- Set-Transmitter/Receiver
- 50 Meters working distance
- Camera DC power supply needed
- Supplies DC power input to the camera - Not PoE



\*supported model only

**4+1 Port Giga Powered Device PoE Switch**

**Features:** Surge Protection. Complies with IEEE802.3af/at/bt.

**PoES-0460G+1G(HPD)**



Downlink ports	4 x 10/100/1000Mbps
Uplink ports	1 x 10/100/1000Mbps (Powered Device)
Total power	55W (Avg:13.75W Max 30W per ch)
Power Supply	Powered by High Power PoE to PD Port or 54v/1.2A PSU (Not Supplied)

**Switch POE 10/100 MBPS**

**Features:** CCTV MODE: Up to 250 meters at 10Mbps, no communication among downlink ports. PoE (8W Max), Built-in Surge Protection. Complies with IEEE802.3af/at.



**PoES-0460C+2I**



**PoES-08120C+2I**



**PoES-08120C+2GI**



Downlink ports	4 x 10/100Mbps	8 x 10/100Mbps	8 x 10/100Mbps
Uplink ports	2 x 10/100Mbps	2 x 10/100Mbps	2 x 10/100/1000Mbps
Total power	60W (Avg:15W Max 30W for ch)	120W (Avg:15W Max 30W for ch)	120W (Avg:15W Max 30W for ch)

**PoES-16200C+2G**



FIBRA

**POES-16250CL+2G+2SFP**



Downlink ports	16 x 10/100Mbps	16 x 10/100Mbps
Uplink ports	2 x 10/100/1000Mbps	2 x 10/100/1000Mbps 2 X SFP
Total power	200W (Avg:12.5W Max 30W for ch)	250W (Avg:15.6W Max 30W for ch)
Keep alive	-	Yes
Display	-	LCD color

**PoES-24300C+2G**



FIBRA

**POES-24370CL+2G+2SFP**



Downlink ports	24 x 10/100Mbps	24 x 10/100Mbps
Uplink ports	2 x 10/100/1000Mbps	2 x 10/100/1000Mbps 2 x SFP
Total power	300W (Avg:12.5W Max 30W per ch)	370W (Avg:15.4W Max 30W per ch)
Keep alive	-	Yes
Display	-	LCD color

**Switch POE 10/100/1000 MBPS**

**Features:** CCTV MODE: Up to 250 meters at 10Mbps, no communication among downlink ports. PoE (8W Max), Built-in Surge Protection. Complies with IEEE802.3af/at.



**PoES-0472GC+2G**



**PoES-08130GCL+2G+2SFP**

FIBRA



**POES-16250GCL+2SFP**

FIBRA



**POES-24370GCL+2SFP**

FIBRA



Downlink ports	4 x 10/100/1000Mbps	8 x 10/100/1000Mbps	16 x 10/100/1000Mbps	24 x 10/100/1000Mbps
Uplink ports	2 x 10/100/1000Mbps	2 x 10/100/1000Mbps 2 x SFP	2 x SFP	2 x SFP
Total power	72W (Avg:18W Max 30W per ch)	120W (Avg:15W Max 30W per ch)	250W (Avg:15.6W Max 30W per ch)	370W (Avg:15.4W Max 30W per ch)
Keep alive	-	Yes	Yes	Yes
Display	-	LCD color	LCD color	LCD color



# HD Series



## Pro

2MP - 5MP - 8MP

Series earmarked for the installer looking for a high-level camera emphasizing the difference in image quality.

The Pro series cameras are suitable for indoor and outdoor applications where professional video surveillance is required.



## Ultra

2MP

Series earmarked for the installer looking for a premium-level camera able to guarantee excellent performances under extreme light conditions. The series can count on both increased wide dynamic range and top-quality sensors. Ultra cameras find their best application in any area where lighting is challenging.

Provision-ISR HD range also includes:

- A series of **PTZ cameras** for wide-area coverage
- A series of **special cameras** specifically designed for non-conventional applications (box, hidden and PIR cameras)

## Comparison based on main features

		Pro	Ultra
Resolution	2MP	●	●
	5MP	●	
	8MP	●	
WDR	Digital	●	
	True		●
Noise reduction	2D-DNR		
	3D-DNR	●	●
IR Type	Smart	●	●
	Visible light		

# HD Cameras

## Model name index

### HD Cameras

Example	Category	Sub-Category	CMOS	Resolution	Lux	Solution	Lens	Color
	D	1	3	8	0	A	28	G
	I	2	3	8	0	A	28	

Category	
B	Body
D	Dome
I	Infra Red (IR) Bullet
M	Mini
T	Tube camera

CMOS	
3	~1/3"

LUX	
0	0 (IR on)
1	0.01
2	0.01 ~ 0.1

Lens	
28	2.8mm
36	3.6mm
37	3.7mm
VF	Vari-focal
MVF	Motorized VF (with auto focus)

Sub-Category	
X	No subCategory
AI	Anti vandal (IR)
C	Pinhole cone shape
I	Infra red (IR)
L	Spotlight shape
PT	Pan/Tilt
S	Smoke detector
V	PIR detector
W	Snake
2	IR 20 m
4	IR 40-60 m
VL	Visible light

Resolution	
2/9	2 MP
4	4 MP
5	5 MP
8	8 MP

Solution	
A	4 in 1 Pro
AU	4 in 1 Ultra

Color	
G	Grey

### PTZ

Example	IR distance	Category	CMOS	Resolution	LUX	Solution	Zoom
I5	50 m	PT Pan Tilt	3   ~1/3"	9   2 MP	0   0 (IR on)	A   HD	X4   x4 zoom
	100 m						X10   x10 zoom

### Speed dome

Example	Category	Lens	Solution	Resolution	Special features
MZ	Mini Speed dome	10   x10 zoom	A   HD	2   2 MP	(IR)   Infra Red
ZP	Speed dome	20   x20 zoom			



PRO cameras 2 MP



**Features:** HD/TVI/CVI/CVBS + PAL/NTSC (Selected by DIP Switch), Image sensor 1/2.9", 25/30 fps, True Day&Night-ICR, Digital WDR, 3D-DNR, Privacy mask, S/N Ratio  $\geq 52$ dB (AGC OFF), White balance (Auto / Manual), CoC Support, OSD Menu (Available via CoC Only), IP67.



DI-320A-28



DI-320A-VF | DI-320A-VF-G



Lens	2.8mm (88°)	2.8-12mm Vari-Focal (88°-33°)
IR Distance	1 LED Array (20m)	3 LED Array (40m)
Power supply	DC12V/270mA	DC12V/620mA
Brackets/junction box	G	F

I2-320A-28



I4-320A-28



I4-320A-VF | I4-320A-VF-G



Lens	2.8mm (88°)	2.8mm (88°)	2.8-12mm Vari-Focal (88°-33°)
IR Distance	1 LED Array (20m)	2 LED Array (40m)	2 LED Array (40m)
Power supply	DC12V/320mA	DC12V/470mA	DC12V/560mA
Brackets/junction box	A	B	B

PRO cameras 5 MP



**Features:** HD/TVI/CVI/CVBS + PAL/NTSC (Selected by DIP Switch), Image sensor 1/2.7", 25/30 fps, True Day&Night-ICR, Digital WDR, BLC, 3D-DNR, Privacy mask, S/N Ratio ≥52dB (AGC OFF), White balance (Auto / Manual), CoC Support, OSD Menu (Available via CoC Only), IP 67.



	DI-350A-28	DI-350A-VF	DI-350A-MVF DI-350A-MVF-G	DAI-350A-MVF
Lens	2.8mm (91°)	2.8-12mm Vari-Focal (84°-32°)	2.8-12mm Motorized Vari-Focal (84°-32°)	2.8-12mm Motorized Vari-Focal (84°-32°)
IR Distance	1 LED Array (20m)	3 LED Array (40m)	3 LED Array (40m)	3 LED Array (40m)
Power supply	DC12V/280mA	DC12V/620mA	DC12V/620mA	DC12V/600mA
Brackets/junction box	G	F	F	H

	I2-350A-28	I4-350A-28	I4-350A-VF	I4-350A-MVF
Lens	2.8mm (91°)	2.8mm (91°)	2.8-12mm Vari-Focal (84°-32°)	2.8-12mm Motorized Vari-Focal (84°-32°)
IR Distance	1 LED Array (20m)	2 LED Array (40m)	2 LED Array (40m)	2 LED Array (40m)
Power supply	DC12V/320mA	DC12V/470mA	DC12V/560mA	DC12V/660mA
Brackets/junction box	A	B	B	B

PRO cameras 8 MP



**Features:** HD/TVI/CVI/CVBS + PAL/NTSC (Selected by DIP Switch), Image sensor 1/2.5", 25/30 fps, True Day&Night-ICR, Digital WDR, 3D-DNR, Privacy mask, S/N Ratio ≥52dB (AGC OFF), White balance (Auto / Manual), CoC Support, OSD Menu (Available via CoC Only), IP 67.



	DI-380A-28	DI-380A-MVF
Lens	2.8mm (89.3°)	2.8-12mm Motorized Vari-Focal (78°-31.3°)
IR Distance	1 LED Array (20m)	3 LED Array (40m)
Power supply	DC12V/270mA	DC12V/620mA
Brackets/junction box	G	F

	DAI-380A-MVF	I2-380A-28	I4-380A-MVF
Lens	2.8-12mm Motorized Vari-Focal (83.5°-32°)	2.8mm (95°)	2.8-12mm Motorized Vari-Focal (82.5°-31.5°)
IR Distance	3 LED Array (40m)	1 LED Array (20m)	2 LED Array (40m)
Power supply	DC12V/320mA	DC12V/470mA	DC12V/560mA
Brackets/junction box	H	A	B



ULTRA cameras 2 MP



**Features:** HD/TVI/CVI/CVBS + PAL/NTSC (Selected by DIP Switch), 25/30 fps, True Day&Night-ICR, True WDR, BLC, 3D-DNR, Privacy mask, S/N Ratio  $\geq 52$ dB (AGC OFF), White balance (Auto / Manual), CoC Support, OSD Menu (Available via CoC Only), IP 67.



DI-320AU-MVF | DI-320AU-MVF-G



DAI-320AU-VF



I4-320AU-MVF



	DI-320AU-MVF   DI-320AU-MVF-G	DAI-320AU-VF	I4-320AU-MVF
Lens	2.8-12mm Motorized Vari-Focal (96°-34°)	2.8-12mm Vari-Focal ( 88°-33° )	2.8-12mm Motorized Vari-Focal (96°-34°)
Image sensor	1/2.8" 2MP Sensor	1/2.9" 2MP Sensor	1/2.8" 2MP Sensor
IR Distance	3 LED Array (40m)	3 LED Array (40m)	2 LED Array (40m)
Power supply	DC12V/660mA	DC12V/660mA	DC12V/620mA
Brackets/junction box	F	H	B



### HD Special cameras

Features: HD/TVI/CVI/CVBS (selectable via DIP switch), 25/30 fps, CoC Support.

	IV-390A37-V2	IV-350A37	BX-391A
			
Resolution	2 MP	5 MP	2 MP
Lens	3.7mm Pinhole Lens (78°)	3.7mm Fixed Lens (73°)	CS Mount
IR Distance	10m (18 IR LED)	10 m (36 IR LED)	
Power supply	DC12V±10%, ~212mA	DC12V/300mA	DC12V±10%, ~80mA

	MW-392A37	MC-392A37	DL-392A37	DS-392A37
				
Resolution	2 MP	2 MP	2 MP	2 MP
Lens	3.7mm Pinhole Lens (83°)	3.7mm Pinhole Lens (78°)	3.7mm Pinhole Lens (78°)	3.7mm Pinhole Lens (78°)
Power supply	DC12V±10%, ~80mA	DC12V±10%, ~72mA	DC12V±10%, ~72mA	DC12V±10%, ~72mA

### HD PTZ cameras

Features: HD/TVI/CVI/CVBS + PAL/NTSC (selectable via DIP switch), privacy mask, ICR auto/day/night, Noise reduction, motion detection, IP66.

	I5PT-390AX4	I5PT-390AX10
		
Resolution	2 MP	2 MP
Lens	4X (2,8-12mm)	10X (5,1-52mm)
Pan/Tilt range	250° horizontal - 65° vertical	250° horizontal - 65° vertical
IR Distance	50m (IR LED ARRAY)	50m (IR LED ARRAY)
Power supply	DC12V/2A	DC12V/2A

	MZ-10A-2(IR)	ZE-20A-2(IR)	ZP-20A-2(IR)
			
Resolution	2 MP	2 MP	2 MP
Lens	x10 (4.7-47mm)	20X(4.9-97mm)	20X (4.9-97mm)
Pan/Tilt range	360° (Endless)/180° (Auto Flip)	360° (Endless)/180° (Auto Flip)	360° (Endless)/180° (Auto Flip)
IR Distance	60m IR LED	100m IR LED Array	100m IR LED Array
Power supply	DC12V/2A	12VDC/2A	124VAC/3A
Brackets/junction box	pag 47	pag 47	pag 47

# DVR

## Digital Video Recorders



DVR systems are the “heart” of any CCTV installation.

All information streamed from the cameras accumulates in the DVR. The DVR captures the video signal coming from the camera, converts and saves it in digital format.

Therefore, the DVR’s quality is as important as the cameras’ when it comes down to the final video resolution. Moreover, since all the recording data is saved and rewritten repeatedly on the DVR, it must be an extremely reliable and high-standard product. Provision-ISR DVRs are designed and manufactured according to researched and practiced knowledge over many years of experience.

All DVRs use the advanced H.264-H.265 video compression format to deliver maximum video quality while using minimum storage volume.

Provision-ISR DVRs are made of the highest quality components and are adapted to work in a wide range of different conditions and applications.

All of our DVRs stand out for their “full feature” operating system with a user-friendly graphical interface running from its powerful processor.

Depending on the model, our DVRs include digital VGA and HDMI monitor out, analog video out, audio in/out, RS-485 for PTZ control, and alarm in/alarm out sockets.

The range of DVRs is also supported by a robust network function for remote monitoring, complete remote configuration and mobile device application for remote monitoring.

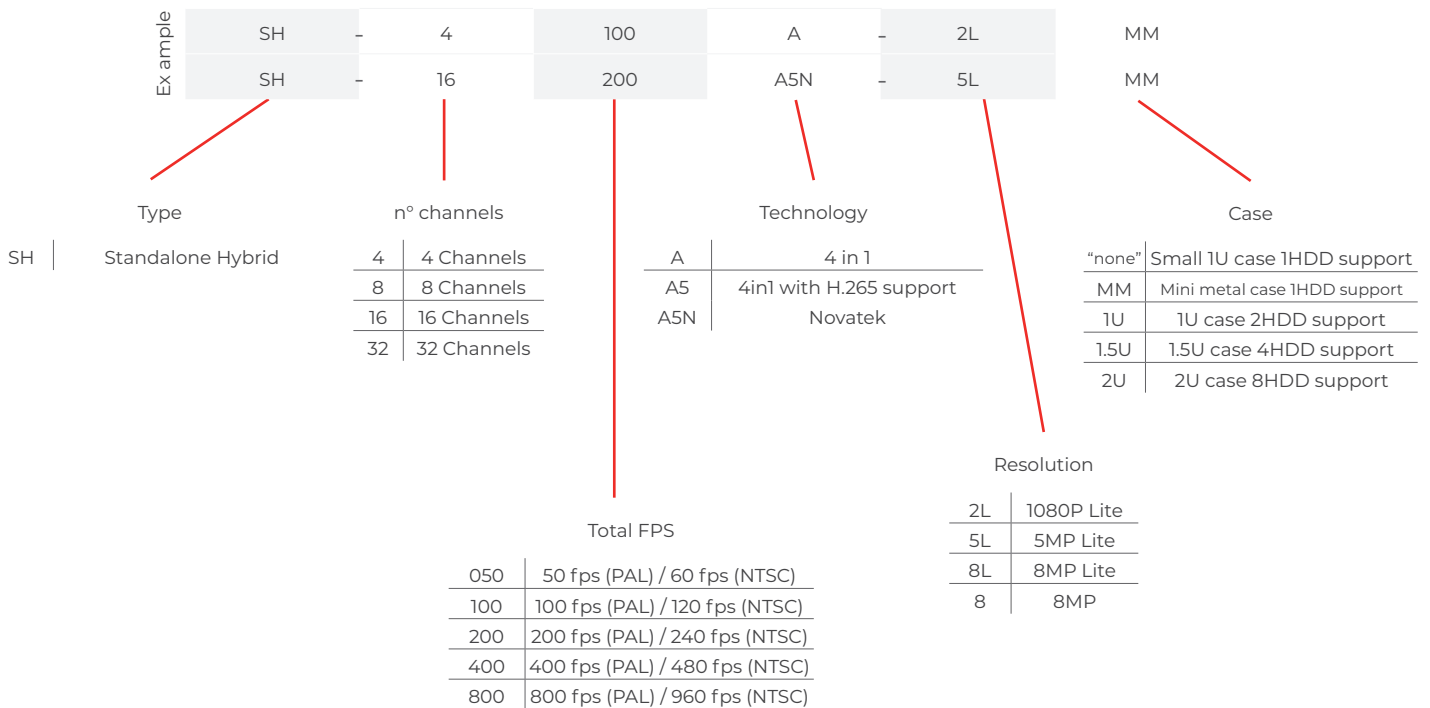

### Model name index



DVR 4 Ch



Features: HD / CVI / TVI / CVBS + IP, H.265, Backup format AVI/DAT, VMS Support, Video Analytics Support, Provision Cam2 APP, Browsers and WEB connection IE,NAT, DDNS, IP Cloud APP & Web page connection.



	SH-4100A5N-2L(MM)	SH-4050A5N-5L(MM)	SH-4050A5N-5L
			
Resolution	2 MP lite	5 MP lite	5 MP lite
Analog+IP Channels	4 + 2	4 + 2	4+2
Video output	HDMI: 1080P VGA: 1280x1024 CVBS(Spot)	HDMI: 1080P VGA: 1280x1024 CVBS(Spot)	HDMI: 1080P VGA: 1280x1024 CVBS(Spot)
Max. Recording	Analog: 2MP Lite @ 25FPS IP: 3MP @ 25FPS	Analog: 5MP Lite @ 25FPS IP: 5MP @ 25FPS	Analog: 2MP Lite @ 25FPS IP: 3MP @ 25FPS
Alarm	-	-	4 IN / 1 OUT
Audio	1 IN / 1 OUT	1 IN / 1 OUT	4 IN / 1 OUT
Hard Disk	1 SATA ( 6 TB Max)	1 SATA (8 TB Max)	1 SATA (8 TB Max)
Power supply	DC12V 2A (Power supply included)	12V/2A (Power supply included)	DC12V 2A (Power supply included)
Dimensions	255x220x43mm	255x220x43mm	300x250x45mm

4K SH-4050A5N-8L(MM)



4K SH-4050A5-8L

	SH-4050A5N-8L(MM)	SH-4050A5-8L
		
Resolution	8 MP lite	8MP lite
Analog+IP Channels	4 + 2	4+2 / 0+6
Video output	HDMI: 4K HDMI2: 1080P VGA: 1280x1024 CVBS (spot)	HDMI: 4K HDMI2: 1080P VGA: 1280x1024 CVBS (spot)
Max. Recording	Analog: 5MP Lite @ 25FPS IP: 5MP @ 25FPS	Analog: 5MP Lite @ 25FPS IP: 5MP @ 25FPS
Alarm	-	-
Audio	1 IN / 1 OUT	1 IN / 1 OUT
Hard Disk	1 SATA (8 TB Max)	1 SATA (8 TB Max)
Power supply	12V/2A (Power supply included)	12V/2A (Power supply included)
Dimensions	255x220x43mm	255x220x43mm

DVR 8 Ch

Features: HD / CVI / TVI / CVBS + IP, H.265, Backup format AVI/DAT, VMS Support, Video Analytics Support, Provision Cam2 APP, Browsers and WEB connection IE,NAT, DDNS, IP Cloud APP & Web page connection.



	SH-8100A5N-2L(MM)	SH-8100A5N-5L(MM)	SH-8100A5N-5L
			
Resolution	2 MP lite	5MP lite	5MP lite
Analog+IP Channels	8 + 4	8 + 4	8 + 4
Video output	HDMI: 1080P VGA: 1280x1024	HDMI: 1080P VGA: 1280x1024 CVBS(Spot)	HDMI: 1080P VGA: 1280x1024 CVBS(Spot)
Max. Recording	Analog: 2MP Lite @ 25FPS IP: 5MP @ 25FPS	Analog: 5MP Lite @ 25FPS IP: 5MP @ 25FPS	Analog: 5MP Lite @ 25FPS IP: 5MP @ 25FPS
Alarm	-	-	8 IN / 2 OUT
Audio	1 IN / 1 OUT	1 IN / 1 OUT	8 IN / 1 OUT
Hard Disk	1 SATA ( 6 TB Max)	1 SATA (6 TB Max)	1 SATA ( 8 TB Max) 1 ESATA port
Power supply	DC12V 2A (Power supply included)	12V/2A (Power supply included)	DC12V 2A (Power supply included)
Dimensions	255x220x43mm	255x220x43mm	300x250x45mm

## DVR 8 Ch

Features: HD / CVI / TVI / CVBS + IP, H.265, Backup format AVI/DAT, VMS Support, Video Analytics Support, Provision Cam2 APP, Browsers and WEB connection IE,NAT, DDNS, IP Cloud APP & Web page connection.



4K SH-8100A5N-8L(MM)



4K SH-8100A5N-8L(1U)



4K SH-8100A5-8(1U)



Resolution	8MP lite	8MP lite	8MP
Analog+IP Channels	8 + 8	8 + 8	8 + 8 / 0 + 16
Video output	HDMI1: 4K HDMI2: 1080P VGA: 1280x1024 CVBS (spot)	HDMI1: 4K HDMI2: 1080P VGA: 1280x1024 CVBS (spot)	HDMI1: 4K VGA: 1280x1024 CVBS (spot)
Max. Recording	Analog: 8MP Lite @ 25FPS IP: 8MP @ 25FPS	Analog: 8MP Lite @ 25FPS IP: 8MP @ 25FPS	Analog: 8MP @ 25FPS IP: 8MP @ 25FPS
Alarm	-	8 IN / 2 OUT	8 IN / 2 OUT
Audio	1 IN / 1 OUT	8 IN / 1 OUT	8 IN / 1 OUT
Hard Disk	1 SATA ( 8 TB Max) 1 ESATA port	2 SATA ( 8 TB Max) 1 ESATA port	2 SATA ( 8 TB Max) 1 ESATA port
Power supply	DC12V 2A (Power supply included)	DC12V 4A (Power supply included)	DC12V 4A (Power supply included)
Dimensions	255x220x43mm	375x275x45mm	375x275x45mm

## DVR 16 Ch

Features: HD / CVI / TVI / CVBS + IP, H.265, Backup format AVI/DAT, VMS Support, Video Analytics Support, Provision Cam2 APP, Browsers and WEB connection IE,NAT, DDNS, IP Cloud APP & Web page connection.



SH-16200A5N-2L(MM)



SH-16200A5N-5L(MM)



SH-16200A5N-5L(1U)



4K SH-16200A5-8L(1U)



Resolution	2MP lite	5MP lite	5MP lite	8MP lite
Analog+IP Channels	16 + 2	16 + 8	16 + 8	16 + 8 / 8 + 16
Video output	HDMI: 1080P VGA: 1280x1024 CVBS(Spot)	HDMI: 1080P VGA: 1280x1024 CVBS(Spot)	HDMI: 1080P VGA: 1280x1024 CVBS(Spot)	HDMI1: 4K HDMI2: 1080P VGA: 1280x1024 CVBS (spot)
Max. Recording	Analog: 2MP Lite @ 25FPS IP: 5MP @ 25FPS	Analog: 5MP Lite @ 25FPS IP: 5MP @ 25FPS	Analog: 5MP Lite @ 25FPS IP: 5MP @ 25FPS	Analog: 8MP Lite @ 25FPS IP: 8MP @ 25FPS
Alarm	-	-	16 IN / 4 OUT	16 IN / 4 OUT
Audio	1 IN / 1 OUT	1 IN / 1 OUT	8 IN / 1 OUT	16 IN / 1 OUT
Hard Disk	1 SATA ( 6 TB Max) 1 ESATA port	1 SATA ( 6 TB Max) 1 ESATA port	2 SATA ( 8 TB Max) 1 ESATA port	2 SATA ( 8 TB Max) 1 ESATA port
Power supply	DC12V 2A (Power supply included)	DC12V 2A (Power supply included)	DC12V 4A (Power supply included)	DC12V 4A (Power supply included)
Dimensions	255x220x43mm	255x220x43mm	375x275x45mm	375x275x45mm

## DVR 32 Ch

Features: HD / CVI / TVI / CVBS + IP, H.265, Backup format AVI/DAT, VMS Support, Video Analytics Support, Provision Cam2 APP, Browsers and WEB connection IE,NAT, DDNS, IP Cloud APP & Web page connection.



SH-32400A5-5L(1.5U)



4K SH-32200A5R-8(2U)



Resolution	5MP lite	8MP
Analog+IP Channels	32 + 8 / 24 + 16	32 + 32 / 0 + 64
Video output	HDMI: 1080P VGA: 1280x1024 CVBS(Spot)	HDMI1: 4K HDMI2: 1080P VGA: 1280x1024 CVBS (spot)
Max. Recording	Analog: 5MP Lite @ 25FPS IP: 5MP @ 25FPS	Analog: 8MP @ 25FPS IP: 8MP @ 25FPS
Alarm	16 IN / 4 OUT	16 IN / 4 OUT
Audio	16 IN / 1 OUT	16 IN / 1 OUT
Hard Disk	4 SATA ( 8 TB Max)	8 SATA ( 8 TB Max) 1 ESATA port
Power supply	AC110-220V	AC110V/220V
Dimensions	440X390X80mm	430x445x97mm





## Accessories range

Provision-ISR is a One-Stop-Shop for all CCTV product needs.

We have created a full range of CCTV accessories (test monitors, power supplies, brackets, junction boxes, connectors, baluns, Etc.) matching all types of CCTV installations.

We understand the need for tested and reliable CCTV accessories and set high-quality standards for all products.

### USB Alarm BOX



Expand your device's alarm capabilities using our plug-and-play IO-1606 alarm box! All you need to do is plug the alarm box to the device, using the supplied USB cable, and immediately get additional 16 alarms in and 6 alarms out!

IO-1606		
Connectivity	Allarmi Input	16 Dry contacts
	Allarmi Output	6 Dry contacts
	Connection Interface	Micro USB
	Power supply	5VDC/1A
	Power Consumption	<5W

Housing	Bracket	Wall Mount
	Dimensions	140mmx74mmx29mm
	Weight(gross)	180g
	Work Environment	-10°C~50°C, 10%~90% Humidity

### Video server

#### DVS-IP5-4

- Video input: 1CH Standard BNC (1.0Vp-p, impedance : 75Ω)
- Supported resolution: 4 MP
- Frame rate: 1-25 / 30 FPS
- Noise reduction: Yes
- Motion detection: Yes
- Privacy mask: Yes
- Video analytics: Yes
- Image orientation: Mirror / flip / corridor mode
- Multi-stream: 4 MP / 3 MP / 2 MP / 1 MP / D1 / CIF (1-25/30 FPS)
- Bit rate: 64 Kbps - 6 Mbps
- Encode mode: VBR/CBR
- Analog video output: CVBS (BNC)
- Audio input: Yes; Audio output: Yes
- SD card: Up to 128 Gb (Micro SD)
- Power supply: DC12V-300mA / PoE-3W
- Alarm: 1 In / 1 Out
- Video compression: H.264-H265
- Dimensions: 140 mm x 75 mm x 30 mm
- Operation temperature: -20°C / 55°C





## HDMI Accessories

### PR-HDMtoVGA

HDMI to VGA

Converts HDMI to VGA output

- Supports: all HD formats up to 1080P @ 30Hz
- Support HDMI 1.4b
- No support for HDMI audio (Will be lost)
- No power required



### PR-HDeX(4K)

HDMI Repeater

It repeats and regenerates an entering HDMI signal and allows a second HDMI cable for a total of 40m(131ft).

- Supports: all HD formats up to 4K @ 30Hz
- Support HDMI 1.4b
- Support up to 40 meters total transmission distance (AWG 26 cable standard)
- 1080P resolution: input up to 15 meters, output up to 25 meters
- 4K resolution: input up to 5 meters, output up to 8 meters
- Note: working distance may be affected by the cable quality and length.
- No power required



### PR-SP102(4K)

Splitter HDMI 1 a 2

It splits a single HDMI input signal into 2 identical output signals.

- Split one HDMI input signal into 2 HDMI output signals
- Support HDMI resolution up to 4K@30Hz
- Support digital audio format: DTS-HD/Dolby-true HD/DTS/Dolby-AC3/DSD/HD(HBR)
- Supported HDMI cable distance: (AWG 26 cable standard)
- 1080P resolution: input up to 15 meters, output up to 15 meters
- 4k resolution: input up to 8 meters, output up to 8 meters
- Note: Working distance may be affected by the cable quality and length.
- DC5V power supply needed (USB Power cable included)



### PR-SP104(4K)

Splitter HDMI da 1 a 4

It splits a single HDMI input signal into 4 identical output signals.

- Separate 1 HDMI in to 4 HDMI out
- Support HDMI resolution up to 4K@30Hz
- Support digital audio format: DTS-HD/Dolby-true HD/ DTS/ Dolby-AC3/ DSD/ HD(HBR)
- Supported HDMI cable distance: (AWG 26 cable standard)
- 1080p resolution: input up to 15 meters, output up to 15 meters
- 4k resolution: input up to 8 meters, output up to 8 meters
- Note: Working Distance may be affected by the cable quality and length
- Include DC5V power supply



### PR-SW301(4K)

HDMI Switcher 3 a 1

It incorporates the connection of 3 HDMI sources into a single HDMI display. After connection, you can select the input manually or automatically by the device.

- Compatible with HDMI 1.4a
- Support up to 4K@30Hz.
- Deep color 12bit per channel
- "Smart switching" function that can detect live HDMI signal in different channels and switch to it automatically
- No power supply required for standard installation. If the HDMI output cable exceeds 5m – a CD5V power supply will be required (Not included)



## HDMI Accessories



### PR-4IN1-Con

Analog HD to HDMI/VGA/BNC Converter

It converts the analog HD signal to an HDMI/VGA/BNC signal for direct connection to a standard display

- Up to HD 2MP signals (AHD/CVI/TVI/CVBS)
- HDMI output compatible with HDCP, HDMI1.4
- HDMI output resolutions: 720P@50/60Hz, 1080P@50/60Hz
- VGA output resolutions: 800x600@60Hz, 1024x768@60Hz, 1366x768@60Hz, 1280x720@60Hz, 1920x1080@60Hz
- Selectable output and resolution by a physical button on the device
- Supports both NTSC/PAL Video inputs –Automatic detection
- Maximum output distance: HDMI: 20 meters, VGA: 5 meters, CVBS: 500 meters



### PR-HDoNet-E

HDMI extender su Cat5e/Cat6

It converts the analog HD signal to an HDMI/VGA/BNC signal for direct connection to a standard display

- Working distance: up to 10m distance over cat5e cable, up to 20m over Cat6 cable
- HDMI 1.3&3D support
- Support video resolution of up to 1080P@60Hz
- Supporta formati audio: DTS-HD/Dolby-true HD/LPCM7.1/DTS/Dolby AC3/DSD
- Power supply not required



### PR-HDoNet+

HDMI extender su Cat5e/Cat6

It converts the analog HD signal to an HDMI/VGA/BNC signal for direct connection to a standard display

- Working distance: up to 40m distance over cat5e cable, up to 60m over Cat6 cable
- HDMI 1.3&3D support
- Deep color a 12Bit e larghezza di banda fino a 225Mhz
- 12Bit deep color and bandwidth of up to 225Mhz support
- Support video resolution of up to 1080P@60Hz
- Supported Audio formats: DTS-HD/Dolby-true HD/LPCM7.1/DTS/Dolby- AC3/DSD
- IR signal transmission (PR-HDoNet(IR) model only)
- DC5V power supply included



### PR-HDKVMoNet

Extender HDMI USB KVM su Cat5r/Cat6

It transmits HDMI + USB + IR signals over Ethernet cable

- Working distance: up to 100m distance over cat5e cable, up to 130m over Cat6 cable
- HDMI1.3 & 3D Support
- 12Bit deep color and bandwidth of up to 225Mhz support
- Support video resolution of up to 1080P@60Hz
- Supported Audio formats: DTS-HD/Dolby-trueHD/LPCM7.1/DTS/ DolbyAC3/DSD
- Support USB2.0 Keyboard and mouse transmission
- Support IR signal transmission
- DC5V power supplies included



## Amplified Horn Speaker

### PR-HS30W

Amplified Horn Speaker

- Total Distortion: 5% Max at 1KHz 1W
- Resonance Frequency: 700 ± 15%Hz at 1V, 25°C
- Rated Frequency Range: 300Hz ~ 5.5K Hz (-20dB band)
- Sound Pressure Level: 112 ± 3dB 1w/m @ 1K Hz
- Rated Impedance: ACR 8 Ohm
- Work Environment: Temperature -20°C~+40°C, Humidity 45%~85%
- Dimensions: 285(W) × 205(H) × 280(L)mm
- Weight: 2.1kg ± 10%
- Power Input: 12VDC/3A





## Balun / High power balun

### PTR-101V-HD-8

1CH 8MP Video Passive Balun

- Passive transmission - No power required
- 8MP 4in1 support: AHD / CVI / TVI / CVBS.
- Transmission Distance: AHD / CVBS - 200M / CVI / TVI - 150M. •Friendly "Tool Free" Terminal Connector
- Built-in TVS for Surge Protection
- Anti Static Design
- Wave Filter Design
- Designed for Cat.5e/6 Cables



### PTR-102VP-HD-8

1CH 8MP Video + Power Passive Balun

- Passive transmission - No additional power required
- 8MP 4in1 support: AHD / CVI / TVI / CVBS.
- Transmission Distance: AHD / CVBS - 200M, CVI / TVI - 150M
- Friendly "Tool Free" Terminal Connector
- Built-in TVS for Surge Protection
- Anti Static Design
- Wave Filter Design
- Designed for Cat.5e/6 Cables



### PTR-103VHP-HD

1CH HD Balun video + High power

- Passive transmission - No additional power required
- 5MP 4in1 support: AHD / CVI / TVI / CVBS
- Transmission Distance: AHD / CVBS / CVI / TVI - 200M
- Friendly "Tool Free" Terminal Connector
- Built-in TVS for Surge Protection
- High-Power Input: 12-36VDC
- Power output: 12VDC Stable Output
- Anti Static Design
- Wave Filter Design
- Designed for Cat.5e/6 Cables



## Connectors

PR-C01



CONNECTOR  
BNC male to RCA female

PR-C03



"T" CONNECTOR BNC  
male to 2 BNC female

PR-C04



CONNECTOR  
BNC female to RCA male

PR-C07



CONNECTOR  
BNC female to BNC female

PR-C08



CONNECTOR  
DC jack male

PR-C09



CONNECTOR  
DC jack female

PR-C10



DC CABLE WITH MALE  
JACK 25 cm length

PR-C12



BNC PLUG

PR-C13



BNC PLUG  
(one set with three pcs) for  
ratchet BNC cramping tool

PR-C14



DC SPLITTER 1-4

**Power supplies**

**PR-12V1A-A**

Power supply 12V 1A

Stable power signal to support clear images  
Over-current protection  
Short circuit protection



**PR-12V3A**

Power supply 12V 3A

Stable power signal to support clear images  
Over-current protection  
Short circuit protection



**PR-12V5A**

Power supply 12V 5A

Stable power signal to support clear images  
Over-current protection  
Short circuit protection



**PR-12V5A-4**

Power supply 12V 1A +4 SPLITTER

Stable power signal to support clear images  
Over-current protection  
Short circuit protection



**PR-12V5A-4T**

Terminal block 12VDC 5A power supply

Stable power signal to support clear images  
Over-current protection  
Short circuit protection



**PR-5A8CH+**

8 CH Power supply

Output Voltage: DC12V  
Output Current: 5 Amp  
Backup Battery Support: No



**PR-5A8CH-B**

8 CH Power supply

Output Voltage: DC12V  
Output Current: 5 Amp  
Backup Battery Support: Yes (up to 7Ah)



**PR-10A9CH+**

9 CH Power supply

Output Voltage: DC12V  
Output Current: 10 Amp  
Backup Battery Support: No



**PR-10A9CH-B**

9 CH Power supply

Output Voltage: DC12V  
Output Current: 10 Amp  
Backup Battery Support: Yes (up to 17Ah)



**PR-12A16CH+**

16 CH Power supply

Output Voltage: DC12V  
Output Current: 12 Amp  
Backup Battery Support: No



**PR-20A16CH (1U)**

16 CH Power supply

Output Voltage: DC12V  
Output Current: 20 Amp  
Backup Battery Support: No





## Test Monitor

### TM-434in1-8

4.3" TFT LCD Test monitor

- |  |   |
|--|---|
| <ul style="list-style-type: none"> <li>·8MP 4in1 support: AHD / CVI /TVI / CVBS</li> <li>·Image settings support</li> <li>·12VDC Output (Plug Supplied)</li> <li>·5VDC Output (Micro USB Plug Supplied)</li> <li>·Audio in with Built-in Speaker</li> <li>·PAL/NTSC Support</li> </ul> | <ul style="list-style-type: none"> <li>·Status LED Indicators</li> <li>·Built-In Long-Life Rechargeable Battery</li> <li>·Hands-Free Operation (Arm strap supplied)</li> <li>·Light Weight</li> </ul> |
|--|---|



### TM-54in1-2

5" TFT LCD Test monitor

- |  |  |
|--|--|
| <ul style="list-style-type: none"> <li>·2MP 4in1 support: AHD / CVI /TVI / CVBS</li> <li>·BNC x 1, VGA x 1 Input</li> <li>·Image settings support</li> <li>·12VDC Output (Plug Supplied)</li> <li>·5VDC Output (Micro USB Plug Supplied)</li> <li>·Audio in with Built-in Speaker</li> </ul> | <ul style="list-style-type: none"> <li>·PAL/NTSC Support</li> <li>·Status LED Indicators</li> <li>·Built-In Long-Life Rechargeable Battery</li> <li>·Hands-Free Operation (Arm strap supplied)</li> <li>·Light Weight</li> </ul> |
|--|--|



### TM-54in1-8

5" TFT LCD Test monitor

- |  |  |
|--|--|
| <ul style="list-style-type: none"> <li>·8MP 4in1 support: AHD / CVI /TVI / CVBS</li> <li>·Image settings support</li> <li>·BNC x 1, VGA x 1 Input</li> <li>·12VDC Output (Plug Supplied)</li> <li>·5VDC Output (Micro USB Plug Supplied)</li> <li>·Audio in with Built-in Speaker</li> </ul> | <ul style="list-style-type: none"> <li>·PAL/NTSC Support</li> <li>·Status LED Indicators</li> <li>·Built-In Long-Life Rechargeable Battery</li> <li>·Hands-Free Operation (Arm strap supplied)</li> <li>·Light Weight</li> </ul> |
|--|--|



## Keyboards

### IP-KEY01

Keyboard with joystick for IP PTZ  
\*Available upon request



### C-06

Keyboard with joystick for analog speed dome (RS-485) and supporting DVRs/NVRs  
\*Available upon request



Lenses

03610DCMP-6

<b>Resolution</b>	6MP				<b>Relative Aperture</b>	1.5±5%
<b>Focal-length</b>	3.6-10mm±5%				<b>Mount</b>	CS
<b>Format</b>	1/1.8"				<b>Focus Range</b>	0.3 m ~ ∞
<b>Angle of View</b>	<b>CMOS</b>	<b>Horizontal</b>	<b>Vertical</b>	<b>Diagonal</b>	<b>Weight</b>	43g
	<b>1/1.8"</b>	95°-40°	62°-26°	120°48°	<b>Focus</b>	Manual focus and zoom
	<b>1/2.7"</b>				<b>Iris</b>	Auto
	<b>1/3"</b>				<b>Operating Temperature</b>	-20C°~+60C°
	<b>1/4"</b>				<b>Back Focal-length</b>	6.6mm



02812DCMP-3 V2

<b>Resolution</b>	3MP				<b>Relative Aperture</b>	1.4±5%
<b>Focal-length</b>	2.8-12mm±5%				<b>Mount</b>	CS
<b>Format</b>	d. 6.6(1/2.7")(MAX)				<b>Focus Range</b>	0.2 m ~ ∞
<b>Angle of View</b>	<b>CMOS</b>	<b>Horizontal</b>	<b>Vertical</b>	<b>Diagonal</b>	<b>Weight</b>	42g
	<b>1/2.5"</b>	/	/	/	<b>Focus</b>	Manual focus and zoom
	<b>1/2.7"</b>	103°-30.8°	74.4°-23.3°	138°-40°	<b>Iris</b>	Auto
	<b>1/3"</b>	91°-28°	67.5°-21.2°	120.8°-36°	<b>Operating Temperature</b>	-20C°~+60C°
	<b>1/4"</b>	73°-23.4°	44.8°-14.8°	87.6°-27.8°	<b>Back Focal-length</b>	6.52mm±0.1



0550DCMP-8

<b>Resolution</b>	3MP				<b>Relative Aperture</b>	F1.4±5%
<b>Focal-length</b>	5-50mm±5%				<b>Mount</b>	CS
<b>Format</b>	d. 7(1/2.7")(MAX)				<b>Focus Range</b>	0.3 m ~ ∞
<b>Angle of View</b>	<b>CMOS</b>	<b>Horizontal</b>	<b>Vertical</b>	<b>Diagonal</b>	<b>Weight</b>	180.8g±5g
	<b>1/2.5"</b>	/	/	/	<b>Focus</b>	Manual
	<b>1/2.7"</b>	49.1°-5.6°	36.5°-4.2°	62.7°-7°	<b>Iris</b>	Auto
	<b>1/3"</b>	44.2°-5.1°	32.7°-3.8°	56°-6.3°	<b>Operating Temperature</b>	-20C°~+60C°
	<b>1/4"</b>	32.7°-3.8°	24.4°-2.8°	41.2°-4.7°	<b>Back Focal-length</b>	7.58mm



01250DCMP-3

<b>Resolution</b>	3MP				<b>Relative Aperture</b>	1.5±5%
<b>Focal-length</b>	12-50mm±5%				<b>Mount</b>	CS
<b>Format</b>	d. 6.6(1/1.8")(MAX)				<b>Focus Range</b>	2.5 m ~
<b>Angle of View</b>	<b>CMOS</b>	<b>Horizontal</b>	<b>Vertical</b>	<b>Diagonal</b>	<b>Weight</b>	154.4g
	<b>1/1.8"</b>	33°-8.6°	20°-4.8°	38°-9.8°	<b>Focus</b>	Manual focus and zoom
	<b>1/2.7"</b>	26-6.6°	15°-3.7°	30°-7.6°	<b>Iris</b>	Auto
	<b>1/3"</b>	/	/	/	<b>Operating Temperature</b>	-20C°~+60C°
	<b>1/4"</b>	/	/	/	<b>Back Focal-length</b>	7.45mm±0.1



# Brackets and junction box

## Cameras compatibility

### A - Bullet I2



### B - Bullet I4



### C - Bullet I6



### D - Fish-Eye



### E - Mini dome



### F - Turret/Dome vari-focal



### G - Turret/Dome fixed lens



### H - Anti-vandal dome vari-focal



### I - Anti-vandal fixed lens



### L - PTZ



# Brackets and junction box

## Cameras compatibility





Model	Brackets/Junction boxes		Installation							
Bullet I6	IP66 PR-JB14IP66	IP64 PR-JB14IP64	Wall PR-WB14	optional PR-B10EX	Ceiling PR-CB14	optional PR-B10EX	Pole PR-B50PB	optional PR-CB14	Corner PR-B50ECB	optional PR-CB14
Bullet I4	IP66 PR-JB12IP66	IP64 PR-JB12IP64	Wall PR-WB12	optional PR-B10EX	Ceiling PR-CB12	optional PR-B10EX	Pole PR-B50PB	optional PR-CB12	Corner PR-B50ECB	optional PR-CB12
Bullet I2	IP66 PR-JB12IP66	IP64 PR-JB12IP64	Wall PR-WB12	optional PR-B10EX	Ceiling PR-CB12	optional PR-B10EX	Pole PR-B50PB	optional PR-CB12	Corner PR-B50ECB	optional PR-CB12
IP Fish-EYE FISH-EYE	IP66 PR-B50JB	OR	Wall PR-WB50	optional PR-B10EX	Ceiling PR-CB50	optional PR-B10EX				
IP DMA DMA	Wall PR-WB-A	OR	PR-B10JB	+	Wall PR-WB12	optional PR-B10EX	Ceiling PR-CB12	optional PR-B10EX		



\*Fish-EYE and DMA available only in IP Technology

Model	Brackets/Junction boxes		Installation											
Dome DI-VF	Wall A PR-WB-A	OR	IP66 PR-JB14IP66	IP64 PR-JB14IP64	+	Wall B PR-WB14	optional PR-B10EX	Ceiling PR-CB14	optional PR-B10EX	Pole PR-B50PB	optional PR-WB14	Corner PR-B50ECB	optional PR-WB14	
Dome DI-FIX	Wall A PR-WB-A	OR	IP66 PR-JB12IP66	IP64 PR-JB12IP64	+	Wall B PR-WB12	optional PR-B10EX	Ceiling PR-CB12	optional PR-B10EX	Pole PR-B50PB	optional PR-WB12	Corner PR-B50ECB	optional PR-WB12	
Dome DAI-VF	IP66 * PR-JB14IP66	+	Wall PR-WB14	optional PR-B10EX	Ceiling PR-CB14	optional PR-B10EX	Pole PR-B50PB	optional PR-WB14	Corner PR-B50ECB	optional PR-WB14	OR	Ceiling PR-ICB23		
Dome DAI-FIX	Wall A PR-WB-A	OR	IP66 * PR-JB12IP66	+	Wall PR-WB12	optional PR-B10EX	Ceiling PR-CB12	optional PR-B10EX	Pole PR-B50PB	optional PR-WB12	Corner PR-B50ECB	optional PR-WB12	OR	Ceiling PR-ICB21

\*For DAI installations, please remove the junction box's cover and connect the camera directly to the junction box.

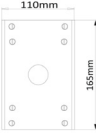
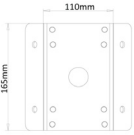
IP - HD / PTZ and Speed Dome brackets

<p><b>PR-B30C</b></p> 	<p><b>PR-B30P</b></p> 	<p><b>PR-B30EC</b></p> 
<p>Ceiling bracket</p>	<p>Pole Mount Bracket</p>	<p>External Corner Bracket</p>
		

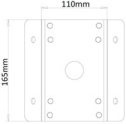
<p><b>PR-B30IC</b></p> 	<p><b>PR-B20C</b></p> 
<p>Internal Corner Bracket</p>	<p>Ceiling Bracket</p>
	

IP Intelligent auto-tracking PTZ

<p><b>PR-WB-Z</b></p> 	<p><b>PR-CB-Z</b></p> 	<p><b>PR-ICB-Z</b></p> 
<p>Wall bracket</p>	<p>Ceiling bracket</p>	<p>In-ceiling bracket</p>

<p><b>PR-B50PB</b></p> 	<p><b>PR-B50ECB</b></p> 
<p>Pole Mount Bracket</p>	<p>External Corner Bracket</p>



IP - HD / Brackets/Junction Boxes

PR-JB14IP66  
PR-JB14IP66-G



Bracket- Junction box for I6-/DI-VF, IP66

PR-JB14IP64



Bracket- Junction box for I6-/DI-VF, IP64

PR-JB12IP66  
PR-JB12IP66-G



Bracket- Junction box for I4-/I2-/DI-Fix, IP66

PR-JB12IP64



Bracket- Junction box for I4-/I2-/DI-Fix, IP64

PR-B10BJB



Junction box for DMA IP cameras

PR-B50JB



Junction Box For Fish-Eye Cameras

PR-WB-A  
PR-WB-A-G



Bracket- Wall bracket for DI-VF, DI-Fix, DAI-Fix, DMA

PR-WB14



Bracket- L shape bracket fits PR-JB14IP66

PR-WB12



Bracket- L shape bracket fits PR-JB12IP66

PR-WB50



Bracket- Wall bracket for FEI

PR-CB14



Bracket- Straight bracket fits PR-JB14IP66

PR-CB12



Bracket- Straight bracket fits PR-JB12IP66

PR-CB50



Bracket- Ceiling bracket for FEI

PR-B10EX



10 cm extension for junction box

PR-B50ECB



External Corner Mount Bracket For Supporting Junction Boxes

PR-B50PB



Pole Mount Bracket For Supporting Junction Boxes and

PR-ICB21



Bracket- In-ceiling mount bracket for DAI-FIX

PR-ICB23



Bracket- In-ceiling mount bracket for DAI-VF

## Ossia VMS

### Dedicated Hardware

Provision-ISR OSSIA VMS is an advanced and reliable software designed for CCTV systems featuring multiple devices that are controlled from a single reliable platform.

Ossia VMS comes with dedicated VMS hardware that are planned, designed, and built by Provision-ISR, with the sole purpose of running the video management software while dedicating 100% of the system resources to the task.

#### OC-MSCL-S(DT)

##### Management server

So Small. So powerful.

OC-MSCL-S(DT) server/workstation is mainly developed for small to medium-sized security systems.

Provision-ISR delivers a winning solution to the field of security with designated hardware that runs embedded Ossia VMS.

This design makes the system far more stable, cost-worthy, and simple to use.

As a result, the device is fully dedicated to its task – CCTV management and operation.



##### Main Features

- 256 Channel support
- 64 Recorder support
- 8GB DDR RAM
- Live View and Playback
- E-Map Monitoring
- Analytics Support
- ONVIF Camera Support
- Auto Report Service Support
- PTZ Support
- Audio Support
- Alarm Support
- Mobile App Support

#### OC-MS-XL(1U)

##### Management server

Provision-ISR's new management server is designed to deal with the most demanding tasks and makes a firm base for more extensive security systems.

Combining high performances and embedded Ossia VMS on the one hand and the ability to manage up to 3K channels on the other, the OCMS-XL(1U) makes a stable and commanding solution for most security needs.



##### Main Features

- Pre-installed Ossia VMS (Server + Client)
- 512 Channels license included
- Full WEB interface
- Total of 256 PC Clients / Mobile App Clients
- Up to 3,000 channels!
- Storage server compatibility
- Set & view AI analytics
- Face database management
- Fisheye special views support
- LPR Monitoring
- User Management
- Map support (including google maps)
- Decoder support
- Audio broadcast

#### OC-RS-16(3U)

##### Storage server

Maximum stability, reliability, and capacity

OC-RS-16(3U) has 16 Hot-Swap HDD trays, RAID capabilities, dual Ethernet, and a power supply.

Provision-ISR's Storage Server was planned, designed, and built for the sole purpose of storing massive amounts of data and keeping it as safe and redundant as it can be.



##### Main Features

- Data capacity increase - allows for a remarkable increase of playback history.
- Redundancy - thanks to RAID5, the data on the disks will be secured against disk faults and errors.
- Flexibility - hot-swap disk trays for fast disk insertion and removal.
- Dual PSU (power supply unit) - one is for backup in case of an electric failure.

# Ossia VMS

## Dedicated Hardware

OC-TS(1U)

### Transfer server

Provision-ISR's Transfer server is designed to stream massive amounts of data from the video devices (IPC/DVR/NVR) to the recording servers and viewing clients.

The transfer server should be used under two circumstances:

- 1) When the user needs to expand the system's bandwidth.
- 2) When the user wants to choose the route from the video devices to the clients.

### Main Features

- High Performance x86 Hardware
- Xeon Processor
- 8GB DDR RAM (Expandable)
- WEB interface for configuration
- 4 x 1Gbps Network Interfaces
- Load Balancing / Network Redundancy Support
- Multicast – Bypassing the recorder login limit



DEC-0104(1U)

### Decoder

Provision-ISR DEC-0104(1U) decoder makes the difference when it comes to durability. The decoder can display up to 144 channels on four separate screens, taking the most resource-demanding task from the client – to itself.

The client is free to deal with the CCTV unexpected tasks such as handling events, playback, alarms, Etc.

Each of the 144 windows is dynamic: the user can choose to use it as a live window, playback window, or an alarm pop-up window!

### Main Features

- 4 HDMI Output (Total)
- 2 x 4K Screen Output
- 1 HDMI Input
- Audio Support
- Live View
- Alarm Popup View
- Playback View
- PTZ control
- Up to 8MP Decoding



IP-KEY02

### Keyboard

Much more than a simple accessory

Provision-ISR IP-KEY-02 keyboard is an excellent addition for control rooms, headquarters, or surveillance rooms.

It allows the control of numerous Decoders and IP PTZ cameras and the choice of the camera layout you want by a single button press.

The operator can easily display up to 144 different channels located on four screens connected to the decoder and fully control IP PTZ cameras for a quick focus on a specific object in the scene.

### Main Features

- PTZ CAMERAS (IP ONLY)
  - Total movement control
  - Preset
  - Cruise
- DECODERS
  - Layout control
  - Live view
  - Playback
  - Alarm window
  - PTZ control (IP and analog)
  - Sequencing channels



# Provision-ISR

## Notes

## Provision-ISR

### Notes



**Provision-ISR**

11 Atir Yeda St, Kfar Saba, Israel

Postal Code: 4442510

Tel: (972-9) 741 7511

Fax: (972-9) 745 7182

---